



CANAL COMPACT CANAL PLUS

Energy
SAVERS
LOW-H₂O

Instrukcja montażu

Dostawa standardowa

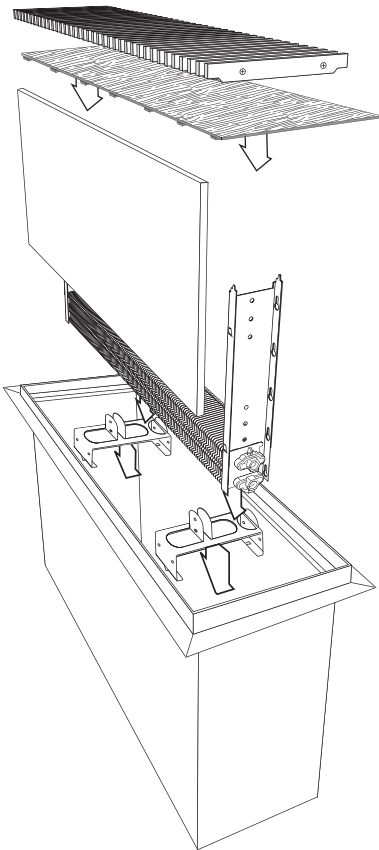

Standardowe podłączenie lewe lub prawe

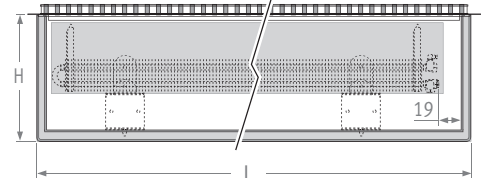
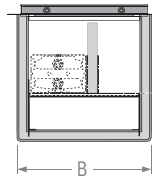

OPCJE

Elastyczne podłączenia

Kod: CCFC.000060

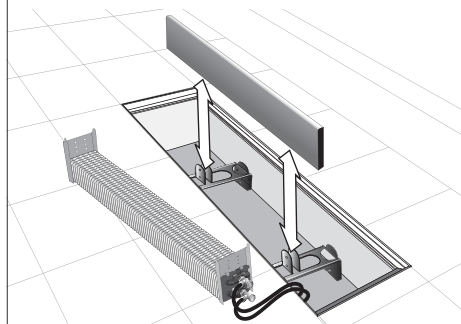
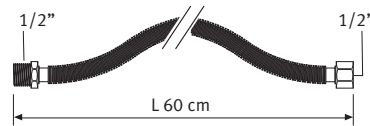

Zasada działania

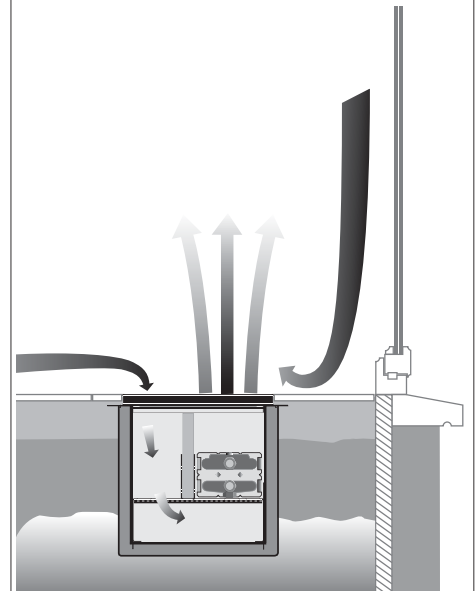

UWAGA !

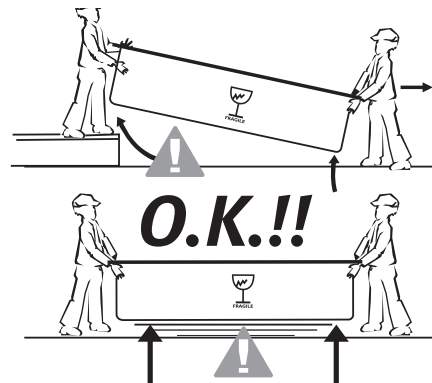
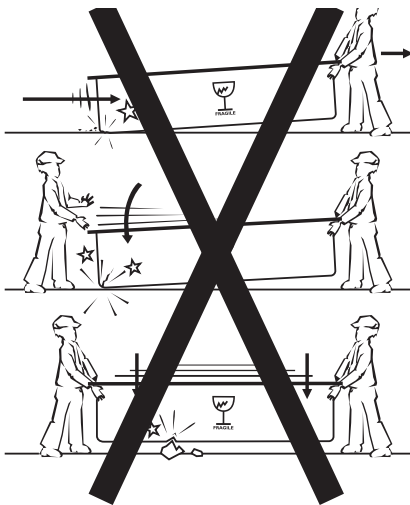





= BRAK GWARANCJI

UWAGA !! Gwarancja na wodoszczelność: należy chronić koryto grzejnika przed uderzeniami oraz przed upadkiem na twarde podłoże.

OPCJE ZESTAWÓW PODŁĄCZEŃ

SET 73 ___ KV 0.6 ___ INSTALACJA DWURUROWA

KOD

COCP.JF2.MA.2...	
COCP.JF2.DW.2...	
COCP.JF2.JB.2...	
COCP.JF2.RD.2...	
COCP.JF2.DS.2...	

złącza zaciskowe

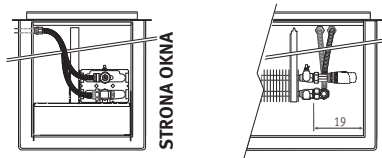

PRZYKŁAD: Zdalna głowica termostaticzna

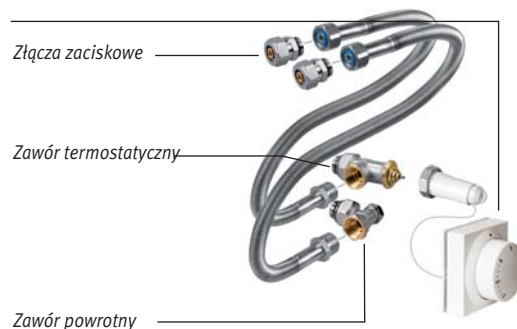

SET 74 ___ KV 0.6 ___ INSTALACJA DWURUROWA

KOD

COCP.E60.MA.2...	
COCP.E60.JB.2...	
COCP.E30.MA.2...	
COCP.E30.JB.2...	
COCP.E60.RD.2...	
COCP.E30.RD.2...	

złącza zaciskowe

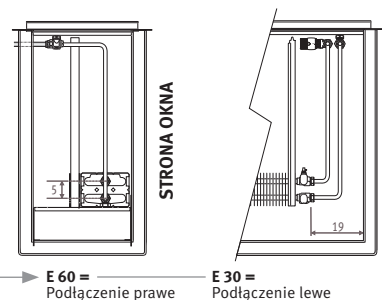



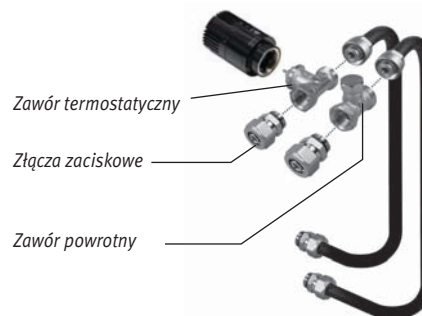

!
Nie pasuje do
CANAL COMPACT

PRZYKŁAD: Głowica w kanale - przedłużone podłączenie



SET 72 ___ KV 0.6 ___ INSTALACJA DWURUROWA

KOD

COMC.JV2.MA.2...	
COMC.JV2.DW.2...	
COMC.JV2.JB.2...	
COMC.JV2.RD.2...	
COMC.JV2.DS.2...	

złącza zaciskowe

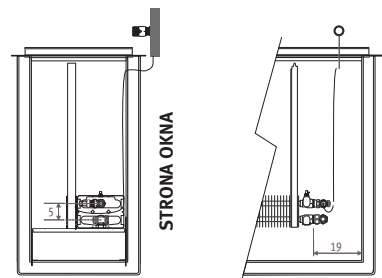

PRZYKŁAD: Zdalna głowica termostaticzna

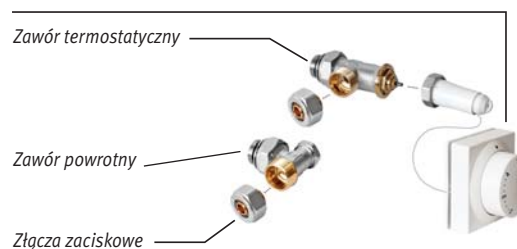

ZŁĄCZA ZACISKOWE

Precyzyjne rury metalowe

Rury syntetyczne

Rury VPE/ALU

Rury stalowe

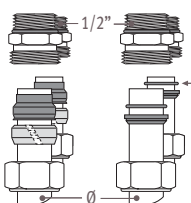
KOD	Ø	
110	10/1	1/2"
112	12/1	
114	14/1	Tylko dla rury 18/1
115	15/1	
116	16/1	
118	18/1	

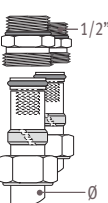
KOD	Ø	
212	12/2	1/2"
213	12/1	
214	14/2	Ø
219	16/1.5	
216	16/2	
217	17/2	
218	18/2	

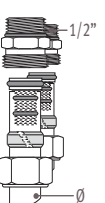
KOD	Ø	
314	14/2	1/2"
316	16/2	
326	16/2.2	
318	18/2	
336	16/2.2	Do rur TECE

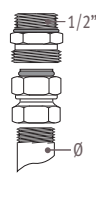
KOD	Ø	
502	1/2"	1/2"
504	3/8"	
Dopłata		Ø

PL UZUPEŁNIJ KOD ZAMÓWIENIA O KOD ZŁĄCZ ZACISKOWYCH ZGODNIE Z RODZAJEM I ŚREDNICĄ UŻYTEJ RURY.

Prawidłowy rodzaj złącz zaciskowych powinien zostać zawarty w kodzie zamówienia zestawu podłączeń (złącza wliczone są w cenę zestawu).

