

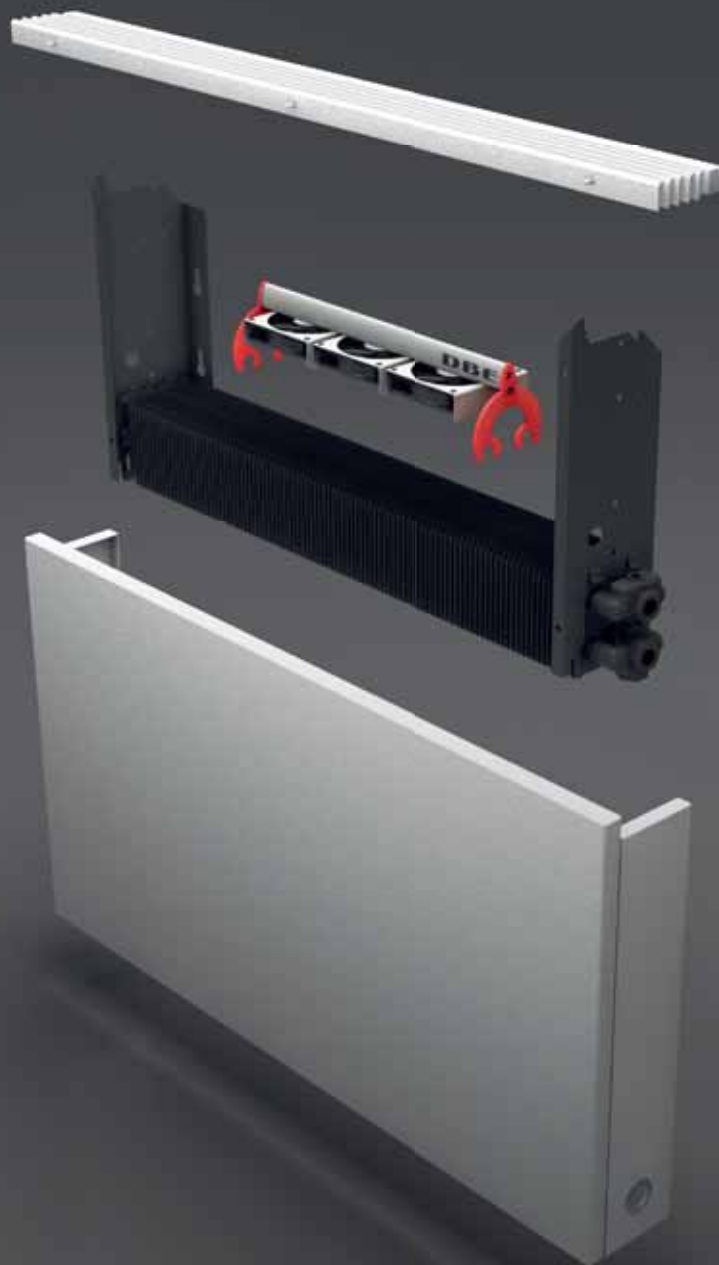

jaga



CZĘŚCI i AKCESORIA € 2017.PL

STRADA - OBUDOWA



Dostawa standardowa

- wstępnie złożona obudowa
- kolor 133 lub 001
- zaślepka w kolorze stali nierdzewnej do panelu bocznego
- dostarczana w kartonowym opakowaniu, które może być użyte do zabezpieczenia na miejscu budowy po instalacji

KOD ZAMÓWIENIA

kod	wys.	dt.	typ	kolor
CSTW.	HHH	LLL	TT.	XXX

L	Typ	H 020		H 035		H 050		H 065		H 095	
		kolor st.	inne	kolor st.	inne	kolor st.	inne	kolor st.	inne	kolor st.	inne
050	06	66,50	113,30	77,60	132,20	84,90	144,80	92,50	157,70	---	---
	10/11	72,60	123,80	83,70	142,50	92,10	156,80	101,60	173,50	---	---
	15/16	79,60	135,30	91,70	156,20	101,00	171,90	111,80	190,50	---	---
	20/21	86,40	147,20	98,50	167,90	108,90	185,70	119,70	204,10	---	---
060	06	72,00	122,70	84,50	144,10	92,50	157,70	100,80	171,90	118,10	201,00
	10/11	78,50	133,80	90,90	154,90	99,90	170,20	110,50	188,20	127,60	217,40
	15/16	84,20	143,20	97,90	166,60	107,60	183,30	119,40	203,20	138,70	235,90
	20/21	91,60	156,00	105,10	179,10	116,20	198,10	127,90	217,80	147,20	250,40
070	06	74,80	127,60	88,00	149,90	97,30	166,10	106,70	182,00	124,80	212,60
	10/11	83,40	141,90	96,30	164,10	106,70	182,10	118,20	201,50	136,40	232,30
	15/16	89,80	152,70	103,80	177,10	115,30	196,50	127,80	217,90	148,10	252,20
	20/21	100,30	170,60	114,30	194,90	127,10	216,30	139,40	237,50	159,60	271,80
080	06	79,20	135,10	93,30	159,00	103,60	176,70	114,50	195,00	135,00	230,10
	10/11	87,80	149,50	101,70	173,30	113,10	192,60	126,00	214,60	146,70	249,70
	15/16	97,20	165,70	112,50	191,50	124,80	212,30	138,80	236,40	161,50	275,00
	20/21	107,40	182,80	122,50	208,50	136,00	231,50	150,00	255,30	172,60	293,80
090	06	83,10	141,40	99,10	168,80	109,80	187,30	121,20	206,40	143,70	244,80
	10/11	91,90	156,60	107,90	183,60	119,80	204,00	133,20	226,80	155,80	265,10
	15/16	102,60	174,70	119,70	204,10	132,50	225,60	147,10	250,50	171,80	292,40
	20/21	112,70	191,80	129,80	220,90	143,70	244,80	158,20	269,20	182,90	311,20
100	06	85,70	146,10	102,10	174,00	113,40	193,50	125,40	213,60	152,70	260,00
	10/11	96,20	163,70	112,60	191,50	125,00	212,80	138,90	236,60	166,20	283,00
	15/16	107,40	182,60	125,00	212,50	138,30	235,20	153,30	260,90	182,80	310,90
	20/21	119,10	202,80	136,50	232,50	151,10	257,40	166,10	282,80	195,50	332,70
110	06	90,30	154,00	107,70	183,60	120,50	205,30	132,70	226,30	163,10	277,80
	10/11	101,40	172,80	118,90	202,40	132,60	225,80	147,10	250,40	177,30	302,00
	15/16	111,90	190,90	130,50	222,50	145,30	247,30	160,80	273,80	193,20	329,00
	20/21	126,30	215,10	144,90	246,50	160,70	273,50	176,20	299,80	208,60	355,00
120	06	98,50	168,00	116,10	197,80	129,90	221,20	144,60	246,30	175,90	299,30
	10/11	112,50	191,40	129,90	221,00	144,60	246,20	161,50	275,00	192,70	327,90
	15/16	125,60	213,90	144,20	245,70	159,90	272,20	178,00	302,90	211,30	359,40
	20/21	145,30	247,40	163,80	279,10	180,70	307,80	198,70	338,10	231,90	394,70
140	06	103,60	176,50	123,50	210,20	139,20	237,10	154,90	263,80	192,20	326,80
	10/11	118,50	202,10	138,50	235,60	155,10	264,20	172,90	294,60	210,10	357,60
	15/16	131,30	223,40	152,30	259,40	169,90	289,20	188,90	321,60	228,30	388,20
	20/21	150,30	255,80	171,30	291,40	190,10	323,50	209,00	355,50	248,20	422,30
160	06	121,90	207,60	144,80	246,40	163,90	279,10	182,50	310,50	---	---
	10/11	139,40	237,60	162,20	276,20	182,40	310,50	203,10	345,80	---	---
	15/16	155,50	264,50	179,20	305,20	200,40	341,00	222,20	378,20	---	---
	20/21	177,10	301,40	201,00	341,90	223,10	379,80	245,00	416,60	---	---
180	06	130,80	222,70	156,00	265,50	176,60	300,70	197,20	335,80	---	---
	10/11	151,50	258,10	176,60	300,80	198,50	337,70	221,10	376,50	---	---
	15/16	169,50	288,40	195,90	333,40	218,40	371,70	242,30	412,30	---	---
	20/21	191,20	325,10	217,50	369,90	241,10	410,30	264,90	450,70	---	---
200	06	146,30	249,20	173,60	295,40	196,10	333,80	219,10	373,00	---	---
	10/11	167,60	285,40	194,70	331,40	218,30	371,70	243,40	414,50	---	---
	15/16	189,80	322,90	218,10	371,10	242,70	412,70	268,90	457,60	---	---
	20/21	212,10	360,80	240,20	408,70	266,00	452,40	292,20	497,10	---	---
240	06	187,60	319,50	219,20	373,10	246,20	419,00	273,50	465,60	---	---
	10/11	212,60	361,80	244,10	415,30	272,20	462,80	301,60	513,20	---	---
	15/16	239,00	406,60	271,70	462,30	300,60	511,20	331,30	563,50	---	---
	20/21	267,00	454,40	299,70	509,90	329,80	561,00	360,40	613,00	---	---
280	06	210,00	357,40	245,50	418,20	277,00	471,30	308,10	524,30	---	---
	10/11	238,00	405,10	273,50	465,60	305,90	520,50	339,30	577,20	---	---
	15/16	268,80	457,20	305,60	520,00	338,70	576,10	373,10	634,80	---	---
	20/21	299,50	509,30	336,00	571,70	370,50	630,20	405,00	688,60	---	---

WYMIENNIK CIEPŁA STRADA

L	STANDARD					TWIN						
	Typ	H 020	035	050	065	095	Typ	H 020	035	050	065	095
050	---	---	---	---	---	---	06	102,20	143,20	145,30	147,50	---
	10	79,20	84,60	86,60	89,90	---	11	---	168,80	172,00	175,40	---
	15	100,70	105,10	109,30	113,60	---	16	---	205,70	208,80	214,00	---
	20	121,30	126,60	131,90	139,40	---	21	---	219,60	224,70	231,20	---
	---	---	---	---	---	---	06	108,60	151,90	153,80	156,00	158,10
060	---	---	---	---	---	---	11	---	178,90	182,30	185,40	188,40
	10	85,20	90,50	92,50	95,80	98,80	16	---	221,20	224,30	229,40	235,90
	15	109,50	113,90	118,10	122,40	128,80	21	---	238,80	244,00	250,50	257,00
	20	133,70	138,80	144,00	151,70	156,80	06	125,40	174,40	176,40	178,60	180,70
	---	---	---	---	---	---	11	---	205,40	208,60	211,90	214,80
070	---	---	---	---	---	---	16	---	257,60	260,70	266,00	272,50
	10	99,60	105,10	107,10	110,40	113,30	21	---	280,90	286,30	292,70	299,10
	15	129,40	133,80	138,10	142,10	148,60	06	133,50	184,90	187,00	189,20	191,30
	20	159,90	165,10	170,30	178,00	183,00	11	---	218,60	222,00	225,00	228,30
	---	---	---	---	---	---	16	---	276,90	279,80	285,10	291,50
080	---	---	---	---	---	---	21	---	303,50	308,60	315,10	321,50
	10	107,00	112,50	114,30	117,60	120,60	06	139,90	193,70	195,80	198,00	200,00
	15	140,30	144,60	148,70	153,00	159,50	11	---	229,10	232,30	235,60	238,60
	20	173,90	179,10	184,50	192,00	197,10	16	---	294,70	297,80	303,00	309,40
	---	---	---	---	---	---	21	---	323,70	329,00	335,40	341,90
090	---	---	---	---	---	---	06	153,80	212,20	214,30	216,50	218,40
	10	112,90	118,30	120,40	123,50	126,60	11	---	251,90	255,00	258,30	261,50
	15	149,80	154,20	158,40	162,80	169,20	16	---	325,50	328,40	333,70	340,10
	20	186,70	191,80	197,10	204,80	209,90	21	---	361,20	366,30	372,90	379,40
	---	---	---	---	---	---	06	162,10	223,00	225,00	227,20	229,30
100	---	---	---	---	---	---	11	---	264,30	267,40	270,70	273,70
	10	125,60	131,00	132,90	136,30	139,20	16	---	344,30	347,30	352,50	359,00
	15	167,00	171,40	175,70	179,90	186,20	21	---	383,90	389,20	395,50	402,00
	20	210,00	215,30	220,50	228,30	233,30	06	169,80	233,70	235,80	238,00	240,00
	---	---	---	---	---	---	11	---	277,30	280,50	283,80	286,80
110	---	---	---	---	---	---	16	---	363,50	366,60	371,90	378,30
	10	132,30	137,90	139,80	143,10	146,10	21	---	406,10	411,60	418,00	424,30
	15	178,20	182,60	186,80	191,10	197,50	06	187,40	260,60	263,70	266,90	270,00
	20	224,20	229,30	234,50	242,20	247,30	11	---	310,80	315,60	320,50	325,00
	---	---	---	---	---	---	16	---	410,70	415,30	423,30	432,80
120	---	---	---	---	---	---	21	---	495,10	502,80	512,40	522,30
	10	139,50	145,10	147,20	150,40	153,40	06	220,80	305,10	308,20	311,50	---
	15	188,30	192,70	196,90	201,20	207,70	11	---	364,00	368,90	373,60	---
	20	238,10	243,30	248,60	256,30	261,50	16	---	487,50	492,10	500,00	---
	---	---	---	---	---	---	21	---	586,70	594,80	604,40	---
140	---	---	---	---	---	---	06	237,90	327,80	330,80	334,10	---
	10	155,80	164,00	167,10	171,90	176,40	11	---	391,40	396,20	401,00	---
	15	212,40	219,00	225,30	231,70	241,50	16	---	528,70	533,30	541,20	---
	20	290,40	298,40	306,30	317,60	325,40	21	---	636,00	643,90	653,50	---
	---	---	---	---	---	---	06	254,40	350,10	353,10	356,50	---
160	---	---	---	---	---	---	11	---	418,50	423,40	428,10	---
	10	185,40	193,70	196,70	201,50	---	16	---	607,50	612,20	620,00	---
	15	255,40	262,00	268,40	274,80	---	21	---	685,00	692,80	702,60	---
	20	348,10	356,00	363,80	375,30	---	06	314,50	433,10	437,20	441,60	---
	---	---	---	---	---	---	11	---	519,40	525,90	532,40	---
180	---	---	---	---	---	---	16	---	755,10	761,10	771,60	---
	10	200,70	208,70	211,70	216,60	---	21	---	858,00	868,50	881,40	---
	15	278,10	284,80	291,20	297,60	---	06	353,20	484,90	489,00	493,40	---
	20	378,70	386,50	394,40	405,80	---	11	---	580,70	587,20	593,50	---
	---	---	---	---	---	---	16	---	846,30	852,40	862,90	---
200	---	---	---	---	---	---	21	---	966,00	976,60	989,40	---
	10	215,70	223,90	226,90	231,60	---	06	353,20	484,90	489,00	493,40	---
	15	321,90	328,50	335,00	341,30	---	11	---	580,70	587,20	593,50	---
	20	409,40	417,20	425,10	436,60	---	16	---	846,30	852,40	862,90	---
	---	---	---	---	---	---	21	---	966,00	976,60	989,40	---
240	---	---	---	---	---	---	06	353,20	484,90	489,00	493,40	---
	10	269,20	280,10	284,20	290,70	---	11	---	580,70	587,20	593,50	---
	15	401,80	410,70	419,20	427,70	---	16	---	846,30	852,40	862,90	---
	20	514,20	524,80	535,30	550,50	---	21	---	966,00	976,60	989,40	---
	---	---	---	---	---	---	06	353,20	484,90	489,00	493,40	---
280	---	---	---	---	---	---	11	---	580,70	587,20	593,50	---
	10	303,60	314,50	318,50	324,90	---	16	---	846,30	852,40	862,90	---
	15	452,40	461,30	469,80	478,40	---	21	---	966,00	976,60	989,40	---
	20	582,00	592,50	602,90	618,20	---	06	353,20	484,90	489,00	493,40	---
	---	---	---	---	---	---	11	---	580,70	587,20	593,50	---

STANDARD

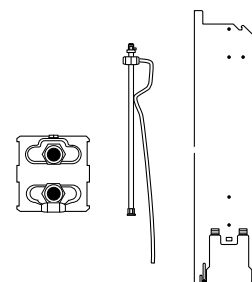

Dostawa standardowa

- wymiennik ciepła Low-H₂O
- konsole ścienne
- przedłużony odpowietznik
- zestaw montażowy
- korek

KOD ZAMÓWIENIA

kod	wys.	dł.	typ
HSTW.	HHH	LLL	TT

TWIN

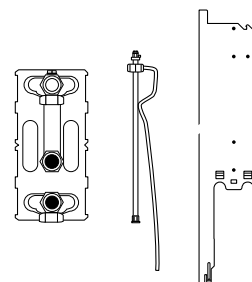

Dostawa standardowa

- wymiennik ciepła Low-H₂O typu Twin
- konsole ścienne
- przedłużony odpowietznik
- zestaw montażowy
- korek

KOD ZAMÓWIENIA

kod	wys.	dł.	typ
HSTW.	HHH	LLL	TT

OPCJA DBE

Patrz zestawy DBE

LINEA PLUS - OBUDOWA



Dostawa standardowa

- wstępnie złożona obudowa
- kolor 133 lub 001
- dostarczana w kartonowym opakowaniu, które może być użyte do zabezpieczenia na miejscu budowy po instalacji

KOD ZAMÓWIENIA

kod	wys.	dł.	typ	kolor
CLIW.	HHH	LLL	TT.	XXX

L	Typ	H 020		H 035		H 050		H 065		H 095	
		kolor st.	inne	kolor st.	inne	kolor st.	inne	kolor st.	inne	kolor st.	inne
050	10/11	51,00	87,00	59,70	102,00	68,00	116,00	76,90	131,30	---	---
	15/16	54,50	93,10	63,60	108,60	73,00	124,30	83,30	141,90	---	---
	20/21	58,60	99,90	68,70	116,90	78,90	134,20	89,10	151,90	---	---
060	10/11	54,50	92,90	64,70	110,50	73,50	125,50	83,30	142,00	100,70	171,70
	15/16	57,40	98,10	68,00	116,10	77,90	132,90	89,00	151,80	108,60	184,90
	20/21	61,80	105,50	73,40	125,20	84,20	143,40	95,30	162,50	114,30	194,60
070	10/11	56,80	96,80	67,60	115,40	77,90	132,90	88,60	151,10	107,10	182,40
	15/16	60,20	102,80	71,40	121,80	82,60	141,20	94,80	161,60	115,30	196,40
	20/21	65,70	112,10	77,90	132,70	90,10	153,60	102,20	174,20	122,10	207,90
080	10/11	60,80	103,50	72,50	123,50	83,70	142,60	95,90	163,20	116,80	198,90
	15/16	65,30	111,20	77,40	131,70	89,60	152,60	103,20	175,60	126,00	214,50
	20/21	70,80	120,50	83,70	142,50	96,90	165,00	110,60	188,10	132,80	226,20
090	10/11	64,10	109,30	77,80	132,60	89,60	152,60	102,10	174,00	125,20	213,00
	15/16	69,10	117,70	83,30	141,60	96,00	163,50	109,90	187,20	134,80	229,50
	20/21	74,40	126,90	89,50	152,40	103,10	175,70	117,20	199,60	141,50	240,90
100	10/11	66,70	113,60	80,90	137,60	93,00	158,60	106,20	180,90	134,00	227,90
	15/16	72,00	122,90	86,50	147,40	99,80	170,10	114,30	194,80	144,00	245,20
	20/21	78,50	133,80	93,90	159,90	107,90	184,20	122,70	209,10	151,90	258,30
110	10/11	70,00	119,50	85,30	145,30	98,80	168,30	112,50	191,50	143,10	243,80
	15/16	74,90	127,80	90,50	154,10	105,10	178,90	120,20	204,50	152,80	260,10
	20/21	81,90	139,70	98,40	167,50	113,90	193,90	129,00	219,70	161,20	274,20
120	10/11	73,90	126,00	89,00	151,90	103,70	176,70	119,70	204,10	151,30	257,70
	15/16	79,30	135,20	94,90	161,70	110,60	188,40	128,00	218,10	161,60	275,00
	20/21	86,60	147,70	103,10	175,80	119,70	204,00	137,10	233,80	170,30	289,60
140	10/11	80,20	136,80	98,00	166,70	114,50	194,80	131,50	224,00	169,10	287,50
	15/16	86,50	147,60	104,50	178,10	122,10	208,00	140,60	239,40	180,20	306,40
	20/21	94,90	161,80	113,90	193,80	132,30	225,30	150,80	256,90	189,80	322,90
160	10/11	95,90	163,30	116,20	198,10	136,40	232,10	156,10	266,00	---	---
	15/16	102,70	174,80	123,50	210,20	144,50	246,10	165,90	282,10	---	---
	20/21	112,60	191,60	134,30	228,60	156,30	266,00	177,70	302,20	---	---
180	10/11	105,40	179,80	128,30	218,70	150,00	255,30	171,90	292,60	---	---
	15/16	113,80	193,90	137,00	233,50	159,60	271,80	183,00	311,40	---	---
	20/21	123,60	210,70	147,80	251,80	171,40	291,70	194,70	331,50	---	---
200	10/11	117,20	199,60	142,00	241,90	165,60	281,70	189,80	323,30	---	---
	15/16	126,00	214,50	151,30	257,50	175,80	299,10	201,50	342,90	---	---
	20/21	136,80	233,00	163,00	277,30	188,30	320,50	214,20	364,60	---	---
220	10/11	138,70	236,00	165,90	282,50	191,80	326,70	218,10	371,00	---	---
	15/16	148,40	252,50	176,10	299,60	203,00	345,60	230,80	392,20	---	---
	20/21	159,60	271,80	188,30	320,40	216,10	367,90	243,80	414,90	---	---
240	10/11	148,30	252,60	177,70	302,30	205,40	349,50	234,00	398,50	---	---
	15/16	159,10	271,00	188,80	321,20	217,60	370,20	247,70	421,50	---	---
	20/21	171,40	291,80	201,90	343,60	231,60	394,20	261,90	445,60	---	---
260	10/11	157,70	268,50	188,90	321,30	219,10	373,10	249,70	424,90	---	---
	15/16	168,40	286,50	199,90	340,00	231,20	393,60	263,20	447,70	---	---
	20/21	182,60	310,70	215,00	365,60	247,20	420,70	279,40	475,20	---	---
280	10/11	165,90	282,20	199,10	339,00	231,30	393,60	263,80	448,90	---	---
	15/16	178,10	302,80	211,70	360,30	244,90	416,60	278,70	474,20	---	---
	20/21	191,80	326,30	226,40	385,20	260,50	443,10	294,40	501,00	---	---

WYMIENNIK CIEPŁA LINEA PLUS

L	STANDARD						TWIN					
	Typ	H 020	035	050	065	095	Typ	H 020	035	050	065	095
050	10	80,70	85,60	88,40	91,60	---	11	---	166,50	169,40	172,20	---
	15	102,20	107,00	111,00	114,80	---	16	---	203,20	206,00	210,80	---
	20	122,60	128,50	133,50	139,20	---	21	---	215,60	220,60	226,50	---
060	10	86,60	91,60	94,50	97,40	100,40	11	---	176,60	179,40	182,40	185,40
	15	111,00	115,80	119,80	123,50	129,60	16	---	218,60	221,70	226,40	232,20
	20	134,70	140,70	145,60	151,50	157,10	21	---	234,90	240,00	245,70	251,70
070	10	101,10	106,20	108,90	112,00	115,00	11	---	203,10	205,90	208,80	211,90
	15	130,80	135,70	139,50	143,40	149,40	16	---	255,00	257,90	262,60	268,70
	20	161,10	167,00	171,90	177,90	183,30	21	---	277,20	282,20	288,00	293,90
080	10	108,50	113,30	116,20	119,40	122,20	11	---	216,20	219,10	222,10	225,00
	15	141,60	146,40	150,50	154,20	160,20	16	---	274,20	277,20	281,90	287,80
	20	175,00	181,00	185,90	191,80	197,50	21	---	299,50	304,60	310,40	316,30
090	10	114,30	119,40	122,20	125,30	128,10	11	---	226,80	229,60	232,50	235,60
	15	151,30	156,00	160,20	163,90	169,80	16	---	292,20	295,10	299,90	305,80
	20	187,70	193,70	198,70	204,50	210,10	21	---	319,80	324,90	330,60	336,60
100	10	127,20	132,10	134,80	138,10	140,90	11	---	249,50	252,30	255,30	258,30
	15	168,40	173,30	177,20	181,00	187,00	16	---	322,80	325,80	330,50	336,40
	20	211,20	217,20	222,10	227,90	233,60	21	---	357,20	362,40	368,10	374,10
110	10	134,00	138,80	141,60	144,80	147,60	11	---	261,90	264,70	267,60	270,70
	15	179,80	184,50	188,40	192,20	198,20	16	---	341,80	344,60	349,30	355,20
	20	225,20	231,20	236,00	242,10	247,60	21	---	380,00	385,00	390,80	396,70
120	10	144,60	152,00	156,30	160,80	165,20	11	---	282,70	287,00	291,40	295,90
	15	194,30	201,30	207,50	213,00	222,00	16	---	369,90	374,20	381,30	390,20
	20	244,10	253,10	260,50	269,20	277,70	21	---	412,00	419,60	428,30	437,20
140	10	158,10	165,60	169,80	174,40	178,70	11	---	307,20	311,60	315,80	320,50
	15	214,70	222,00	227,90	233,60	242,40	16	---	407,00	411,40	418,40	427,40
	20	292,30	301,20	308,50	317,40	325,90	21	---	489,10	496,80	505,40	514,30
160	10	187,70	195,20	199,40	204,10	---	11	---	360,60	364,80	369,10	---
	15	257,60	264,70	270,90	276,40	---	16	---	483,70	488,00	495,20	---
	20	350,00	358,80	366,10	375,10	---	21	---	581,10	588,60	597,20	---
180	10	203,00	210,20	214,60	219,10	---	11	---	387,90	392,10	396,50	---
	15	280,50	287,60	293,70	299,40	---	16	---	524,90	529,30	536,30	---
	20	380,40	389,30	396,70	405,60	---	21	---	630,20	637,70	646,40	---
200	10	218,00	225,30	229,60	234,20	---	11	---	414,90	419,20	423,60	---
	15	324,20	331,30	337,50	343,00	---	16	---	603,80	608,10	615,20	---
	20	411,10	419,90	427,50	436,30	---	21	---	679,10	686,90	695,30	---
220	10	252,60	259,90	264,30	268,80	---	11	---	477,00	481,40	485,70	---
	15	375,70	382,80	388,90	394,50	---	16	---	696,60	701,00	708,00	---
	20	478,40	487,20	494,70	503,60	---	21	---	786,70	794,20	802,80	---
240	10	272,50	282,20	288,00	294,00	---	11	---	514,60	520,50	526,30	---
	15	405,00	414,40	422,60	430,00	---	16	---	750,00	755,70	765,20	---
	20	516,60	528,50	538,30	550,20	---	21	---	850,20	860,40	871,80	---
260	10	290,00	299,90	305,70	311,60	---	11	---	546,30	552,00	557,80	---
	15	430,80	440,40	448,50	455,90	---	16	---	796,50	802,40	811,90	---
	20	550,70	562,50	572,40	584,20	---	21	---	904,40	914,60	926,10	---
280	10	306,60	316,50	322,10	328,30	---	11	---	575,90	581,70	587,50	---
	15	455,70	465,00	473,20	480,70	---	16	---	841,10	846,90	856,40	---
	20	584,30	596,30	606,20	617,90	---	21	---	958,30	968,40	979,90	---

STANDARD

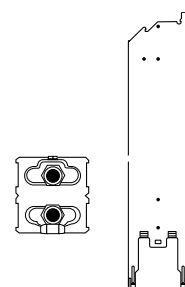

Dostawa standardowa

- wymiennik ciepła Low-H₂O
- konsole ścienne
- odpowietrznik kolankowy
- zestaw montażowy
- korek

KOD ZAMÓWIENIA

kod	wys.	dł.	typ
HLIW.	HHH	LLL	TT

TWIN

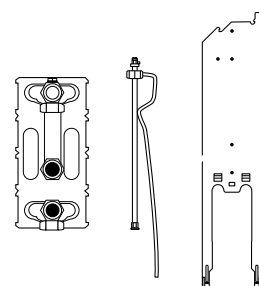

Dostawa standardowa

- wymiennik ciepła Low-H₂O typu Twin
- konsole ścienne
- przedłużony odpowietrznik
- zestaw montażowy
- korek

KOD ZAMÓWIENIA

kod	wys.	dł.	typ
HLIW.	HHH	LLL	TT

OPCJA DBE

Patrz zestawy DBE

TEMPO - OBUDOWA



Dostawa standardowa

- zestaw zawierający:
 - kratkę
 - panel czotowy
 - panel boczny z otworem na głowicę termostatyczną
 - zamknięty panel boczny
- kolor 101
- kompaktowe opakowanie z kartonowymi zabezpieczeniami narożników

KOD ZAMÓWIENIA

<i>kod</i>	<i>wys.</i>	<i>dł.</i>	<i>typ</i>	<i>kolor</i>
CTEW.	HHH	LLL	TT.	101

		H 020	H 030	H 040	H 050	H 060	H 070	H 090
L	Typ							
040	10/11	40,10	46,90	53,70	62,00	68,80	76,20	90,90
	15/16	43,80	51,10	59,00	68,10	75,60	82,40	98,50
	20/21	48,20	56,50	64,80	74,10	83,00	90,20	108,30
050	10/11	42,80	50,00	57,30	65,90	73,20	81,10	96,50
	15/16	46,60	54,40	62,60	72,20	80,10	87,50	104,20
	20/21	51,00	59,90	68,60	78,30	87,50	95,10	114,00
060	10/11	45,40	53,60	61,80	71,50	79,90	88,70	106,20
	15/16	49,70	58,50	67,70	78,40	87,20	95,60	114,30
	20/21	54,50	64,40	74,10	84,70	95,00	103,70	124,70
070	10/11	50,10	59,20	68,50	79,10	88,30	98,10	117,50
	15/16	55,30	65,10	75,30	86,80	96,70	105,70	126,60
	20/21	60,70	71,40	82,10	93,80	104,90	114,70	137,30
080	10/11	52,10	61,80	71,50	82,60	92,40	102,70	123,10
	15/16	57,90	68,10	78,90	90,90	101,10	110,90	132,60
	20/21	63,70	75,10	86,10	98,30	109,90	120,20	144,00
090	10/11	55,90	66,60	77,30	89,30	99,90	111,10	133,50
	15/16	61,60	73,00	84,50	97,50	108,70	119,40	143,10
	20/21	68,50	80,70	92,80	105,70	118,40	129,60	155,20
100	10/11	60,00	71,50	83,30	96,30	107,90	120,20	144,50
	15/16	66,00	78,30	90,90	105,00	117,20	128,80	154,60
	20/21	73,40	86,60	99,80	113,80	127,50	139,50	167,30
110	10/11	63,40	76,10	88,70	102,80	115,50	128,70	155,10
	15/16	71,10	84,30	98,00	113,10	126,30	139,00	166,70
	20/21	77,90	92,20	106,30	121,30	136,10	149,10	178,80
120	10/11	65,30	78,30	91,50	105,90	119,10	132,60	159,90
	15/16	73,40	87,00	101,00	116,60	130,20	143,40	171,90
	20/21	81,20	95,90	110,50	125,90	141,00	154,60	185,20
140	10/11	74,20	89,90	105,40	122,60	138,30	154,50	186,80
	15/16	83,00	99,10	115,60	133,80	149,90	165,60	199,20
	20/21	91,60	108,80	125,90	144,00	161,60	177,80	213,40
160	10/11	82,40	99,40	116,60	135,00	152,30	169,80	205,10
	15/16	93,20	110,80	128,80	148,30	165,90	183,00	219,70
	20/21	104,20	122,90	141,30	160,80	180,00	197,50	236,00
180	10/11	89,00	107,90	127,10	147,30	166,20	185,70	224,70
	15/16	100,70	120,20	140,20	161,50	180,90	199,90	240,20
	20/21	112,40	132,70	153,30	174,50	195,50	214,80	257,30
200	10/11	98,40	119,70	141,20	164,00	185,40	207,40	251,30
	15/16	111,50	133,50	155,80	179,60	201,50	222,90	268,20
	20/21	124,10	147,10	169,90	193,70	217,20	238,90	286,20
220	10/11	108,60	131,50	154,40	178,50	201,40	224,80	271,40
	15/16	123,50	146,90	170,70	196,00	219,50	242,30	290,30
	20/21	138,20	162,50	186,90	212,10	236,90	260,20	310,40
240	10/11	116,10	140,90	165,90	192,20	217,00	242,40	293,30
	15/16	132,10	157,40	183,20	210,60	236,00	260,90	313,00
	20/21	147,10	173,60	199,80	227,10	254,00	279,40	333,50
260	10/11	122,90	149,10	175,50	203,20	229,40	256,30	310,10
	15/16	140,40	167,20	194,40	223,00	250,00	276,30	331,30
	20/21	156,80	184,70	212,40	241,10	269,40	296,20	353,30
280	10/11	135,90	164,50	193,20	223,20	252,00	281,40	339,70
	15/16	154,40	183,50	213,30	244,40	273,50	302,30	361,90
	20/21	171,30	201,40	231,60	262,60	293,40	322,50	384,30
300	10/11	141,60	171,80	201,90	233,50	263,70	294,20	355,60
	15/16	161,10	191,70	222,80	255,40	286,10	316,20	378,80
	20/21	178,90	210,70	242,30	274,90	306,90	337,60	402,20

WYMIENNIK CIEPŁA - TEMPO

STANDARD								
L	Typ	H 020	030	040	050	060	070	090
040	10	71,00	72,00	73,10	73,90	76,80	77,80	80,70
	15	88,10	89,10	92,10	93,90	94,90	96,80	100,80
	20	105,70	106,60	109,50	112,60	113,30	116,20	121,20
050	10	77,80	78,90	79,90	80,70	83,60	84,60	87,50
	15	98,30	99,30	102,20	104,10	105,10	107,00	111,00
	20	118,80	119,70	122,60	125,60	126,40	129,40	134,30
060	10	83,70	84,70	85,80	86,60	89,50	90,50	93,50
	15	107,10	108,20	111,00	112,90	113,90	115,80	119,80
	20	131,00	131,90	134,70	137,90	138,70	141,50	146,40
070	10	98,30	99,30	100,40	101,10	104,10	105,10	107,90
	15	127,10	127,90	130,80	132,60	133,80	135,70	139,50
	20	157,30	158,10	161,10	164,00	165,00	167,70	172,70
080	10	105,50	106,60	107,60	108,50	111,40	112,50	115,30
	15	137,90	138,80	141,60	143,50	144,60	146,40	150,50
	20	171,40	172,20	175,00	178,20	178,90	182,00	186,80
090	10	111,50	112,60	113,60	114,30	117,30	118,30	121,20
	15	147,50	148,50	151,30	153,30	154,20	156,00	160,20
	20	184,20	184,90	187,70	190,90	191,70	194,60	199,40
100	10	124,20	125,30	126,30	127,20	130,00	131,00	134,00
	15	164,60	165,60	168,40	170,30	171,40	173,30	177,20
	20	207,50	208,20	211,20	214,30	215,10	218,00	222,80
110	10	131,00	132,10	132,90	134,00	136,80	137,90	140,70
	15	175,80	176,70	179,80	181,40	182,60	184,50	188,40
	20	221,70	222,40	225,20	228,40	229,10	231,90	236,90
120	10	138,40	139,20	140,40	141,20	144,00	145,10	147,90
	15	185,90	187,00	189,80	191,70	192,70	194,60	198,70
	20	235,60	236,40	239,30	242,40	243,20	246,10	251,00
140	10	153,80	155,30	156,90	158,10	162,40	164,00	168,30
	15	209,00	210,40	214,70	217,60	219,00	222,00	227,90
	20	286,80	288,00	292,30	296,80	298,10	302,50	309,90
160	10	183,40	185,00	186,60	187,70	192,20	193,70	198,00
	15	251,80	253,30	257,60	260,50	262,00	264,70	270,90
	20	344,30	345,60	350,00	354,50	355,70	360,00	367,50
180	10	198,60	200,00	201,60	203,00	207,30	208,70	213,00
	15	274,80	276,20	280,50	283,20	284,80	287,60	293,70
	20	374,90	376,10	380,40	385,00	386,30	390,60	398,10
200	10	213,60	215,30	216,70	218,00	222,30	223,90	228,30
	15	318,40	319,80	324,20	327,00	328,50	331,30	337,50
	20	405,50	406,90	411,10	415,80	417,00	421,30	428,60
220	10	248,20	249,70	251,40	252,60	256,90	258,40	262,60
	15	369,90	371,40	375,70	378,60	380,00	382,80	388,90
	20	472,70	474,10	478,40	483,00	484,30	488,60	495,90
240	10	266,60	268,70	270,70	272,50	278,10	280,10	286,00
	15	397,10	399,10	405,00	408,70	410,70	414,40	422,60
	20	509,10	510,90	516,60	522,70	524,50	530,10	540,00
260	10	284,20	286,30	288,30	290,00	295,80	297,80	303,60
	15	423,00	425,10	430,80	434,60	436,70	440,40	448,50
	20	543,20	544,80	550,70	556,90	558,40	564,30	574,00
280	10	300,80	302,80	304,90	306,60	312,40	314,50	320,10
	15	447,70	449,80	455,70	459,30	461,30	465,00	473,20
	20	577,00	578,60	584,30	590,50	592,30	597,90	607,80
300	10	317,30	319,30	321,40	323,20	328,80	330,90	336,60
	15	472,20	474,30	480,00	483,70	485,70	489,40	497,70
	20	609,90	611,60	617,50	623,50	625,30	631,10	640,90

TWIN							
Typ	H 030	040	050	060	070	090	
11	147,20	147,90	149,00	151,90	152,90	155,90	
	16	176,90	180,10	182,00	182,90	184,90	188,80
		21	185,90	188,90	191,70	192,80	195,80
11			159,60	160,50	161,50	164,40	165,40
	16		195,30	198,30	200,10	201,20	203,20
		21	207,00	209,90	212,60	213,90	216,80
11			169,80	170,60	171,70	174,50	175,70
	16		210,70	213,70	215,60	216,60	218,60
		21	226,40	229,10	231,90	233,30	236,00
11			196,20	197,10	198,20	201,00	202,00
	16		247,20	250,10	252,00	253,10	255,00
		21	268,50	271,30	274,20	275,40	278,30
11			209,60	210,30	211,40	214,30	215,30
	16		266,30	269,20	271,20	272,20	274,20
		21	290,90	293,70	296,60	297,80	300,60
11			220,00	220,80	222,00	224,70	225,80
	16		284,20	287,30	289,20	290,20	292,20
		21	311,10	314,10	317,00	318,00	321,10
11			242,80	243,50	244,70	247,50	248,40
	16		314,90	317,90	319,80	321,00	322,80
		21	348,70	351,50	354,40	355,60	358,60
11			255,00	256,00	257,00	259,80	260,80
	16		333,70	336,70	338,60	339,70	341,80
		21	371,30	374,30	377,20	378,30	381,30
11			268,20	269,00	270,00	272,90	273,80
	16		353,10	356,20	357,90	359,00	361,10
		21	393,80	396,60	399,50	400,70	403,50
11			297,20	298,40	300,00	304,20	305,80
	16		395,00	399,60	402,50	403,80	407,00
		21	476,20	480,60	484,80	486,60	491,00
11			350,30	351,50	353,10	357,40	359,00
	16		471,80	476,40	479,10	480,70	483,70
		21	568,10	572,40	576,80	578,40	582,80
11			377,60	378,90	380,40	384,80	386,30
	16		513,00	517,70	520,40	521,90	524,90
		21	617,30	621,50	625,80	627,70	632,00
11			404,80	405,90	407,50	411,90	413,50
	16		591,80	596,30	599,20	600,60	603,80
		21	666,20	670,50	674,70	676,60	680,90
11			467,00	468,20	469,80	474,10	475,50
	16		684,70	689,30	692,10	693,60	696,60
		21	773,60	777,90	782,40	784,10	788,40
11			501,10	502,80	504,90	510,70	512,70
	16		734,10	740,30	743,80	745,90	750,00
		21	833,00	838,50	844,40	846,80	852,50
11			532,80	534,30	536,40	542,20	544,20
	16		780,70	786,80	790,50	792,40	796,50
		21	887,00	892,90	898,70	901,00	906,80
11			562,40	564,20	566,20	571,80	573,80
	16		825,20	831,30	835,20	837,20	841,10
		21	941,00	946,70	952,50	954,90	960,80
11			592,30	593,90	595,90	601,80	603,80
	16		868,90	875,10	878,90	880,70	884,80
		21	993,80	999,60	1005,40	1007,80	1013,60

STANDARD

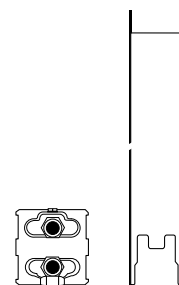

Dostawa standardowa

- wymiennik ciepła Low-H2O
- konsole ścienne
- odpowietrznik kolankowy
- zestaw montażowy
- korek

KOD ZAMÓWIENIA

kod	wys.	dł.	typ
HTEW.	HHH	LLL	TT

TWIN

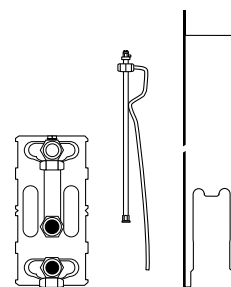

Dostawa standardowa

- wymiennik ciepła Low-H2O typu Twin
- konsole ścienne
- przedłużony odpowietrznik
- zestaw montażowy
- korek

KOD ZAMÓWIENIA

kod	wys.	dł.	typ
HTEW.	HHH	LLL	TT

OPCJA DBE

Patrz zestawy DBE

MAXI - OBUDOWA

MAXI WT



Dostawa standardowa

- wstępnie złożona obudowa
- kolor 233 lub 001
- dostarczana w kartonowym opakowaniu, które może być użyte do zabezpieczenia na miejscu budowy po instalacji

KOD ZAMÓWIENIA

kod	wys.	dł.	typ	kolor	model	podł.
CMAW.	HHH	LLL	TT.	XXX	WT	/70

standardowe podłączenie prawe (/70)
 podłączenie lewe (/20)
 opcja pod wysoki zawór lewa (/30)
 opcja pod wysoki zawór prawa (/60)
 siłownik lub głowica zdalna (/00)

L	Typ	H 044		H 059		H 074	
		kolor st.	inne	kolor st.	inne	kolor st.	inne
063	10/11	265,20	318,30	297,80	357,30	330,40	396,50
	15/16	273,90	328,80	307,40	369,00	341,60	409,90
	20/21	282,90	339,50	317,70	381,30	352,80	423,40
083	10/11	278,70	334,50	315,40	378,50	351,50	421,90
	15/16	288,60	346,40	326,60	391,90	363,50	436,20
	20/21	298,80	358,60	337,20	404,70	376,10	451,30
103	10/11	293,10	351,80	333,10	399,60	372,90	447,40
	15/16	303,80	364,50	344,60	413,60	385,40	462,40
	20/21	314,50	377,30	356,40	427,60	398,20	477,80
123	10/11	306,60	367,90	350,30	420,30	394,20	473,00
	15/16	319,30	383,10	363,50	436,20	408,80	490,70
	20/21	331,50	397,70	376,80	452,20	423,40	508,00
143	10/11	333,10	399,60	382,40	459,00	433,00	519,80
	15/16	345,60	414,60	396,60	475,90	447,70	537,30
	20/21	357,50	429,10	410,10	492,10	462,70	555,20
163	10/11	346,50	415,90	400,60	480,70	454,50	545,50
	15/16	360,00	432,10	415,10	498,10	470,00	564,10
	20/21	373,20	447,80	429,90	515,90	485,60	582,80

MAXI WF



Dostawa standardowa

- wstępnie złożona obudowa
- kolor 233 lub 001
- dostarczana w kartonowym opakowaniu, które może być użyte do zabezpieczenia na miejscu budowy po instalacji

KOD ZAMÓWIENIA

kod	wys.	dł.	typ	kolor	model	podł.
CMAW.	HHH	LLL	TT.	XXX	WF	/70

standardowe podłączenie prawe (/70)
 podłączenie lewe (/20)
 opcja pod wysoki zawór lewa (/30)
 opcja pod wysoki zawór prawa (/60)
 siłownik lub głowica zdalna (/00)

L	Typ	H 044		H 059		H 074	
		kolor st.	inne	kolor st.	inne	kolor st.	inne
063	10/11	293,90	352,70	326,60	391,90	359,10	430,80
	15/16	305,80	366,90	339,70	407,60	373,20	447,80
	20/21	317,30	380,80	352,40	422,80	387,20	464,60
083	10/11	308,20	369,80	344,10	412,90	380,50	456,50
	15/16	320,70	384,90	358,40	430,00	395,90	474,90
	20/21	333,80	400,70	372,40	447,00	410,80	493,00
103	10/11	321,70	386,10	361,50	433,90	401,30	481,50
	15/16	335,90	403,10	376,80	452,20	418,20	501,90
	20/21	350,30	420,30	392,20	470,50	434,30	521,10
123	10/11	335,90	403,10	379,20	455,00	422,90	507,50
	15/16	350,90	421,20	395,90	474,90	440,40	528,50
	20/21	365,90	439,10	412,20	494,70	458,40	550,20
143	10/11	363,10	435,80	412,70	495,30	462,70	555,20
	15/16	380,00	456,00	431,20	517,40	482,80	579,40
	20/21	397,60	477,10	450,10	540,20	502,70	603,30
163	10/11	376,80	452,20	430,20	516,20	483,70	580,50
	15/16	395,20	474,30	450,10	540,20	505,20	606,20
	20/21	413,80	496,50	470,00	564,10	526,20	631,30

OBUDOWA - MAXI

L	Typ	H 044		H 059		H 074	
		kolor st.	inne	kolor st.	inne	kolor st.	inne
063	10/11	272,60	327,00	305,00	366,00	337,80	405,40
	15/16	281,70	338,00	315,40	378,50	348,80	418,60
	20/21	291,10	349,20	325,70	390,80	360,00	432,10
083	10/11	285,70	342,70	322,10	386,50	358,70	430,40
	15/16	295,90	355,10	333,40	400,10	370,30	444,50
	20/21	306,10	367,30	344,10	412,90	382,40	459,00
103	10/11	298,80	358,60	338,60	406,20	378,40	454,00
	15/16	308,90	370,70	350,30	420,30	391,80	470,10
	20/21	319,80	383,80	361,90	434,40	404,40	485,30
123	10/11	311,90	374,30	355,20	426,20	398,90	478,70
	15/16	324,20	389,00	368,80	442,60	413,80	496,50
	20/21	335,90	403,10	382,40	459,00	427,80	513,30
143	10/11	336,30	403,50	386,00	463,20	436,10	523,20
	15/16	348,80	418,60	399,90	480,10	451,20	541,40
	20/21	361,20	433,40	414,20	497,00	466,20	559,50
163	10/11	349,50	419,40	402,90	483,40	456,50	547,80
	15/16	363,10	435,80	417,40	500,90	472,60	567,10
	20/21	376,10	451,30	432,20	518,60	488,70	586,30

MAXI FT



Dostawa standardowa

- wstępnie złożona obudowa
- kolor 233 lub 001
- dostarczana w kartonowym opakowaniu, które może być użyte do zabezpieczenia na miejscu budowy po instalacji

KOD ZAMÓWIENIA

kod	wys.	dł.	typ	kolor	model	podł.
CMAW.	HHH	LLL	TT.	XXX/FT		/70

standardowe podłączenie prawe (/70)
podłączenie lewe (/20)
opcja pod wysoki zawór lewa (/30)
opcja pod wysoki zawór prawa (/60)
siłownik lub głowica zdalna (/00)

L	Typ	H 044		H 059		H 074	
		kolor st.	inne	kolor st.	inne	kolor st.	inne
063	10/11	301,70	361,90	334,40	401,30	367,00	440,50
	15/16	313,30	376,00	347,00	416,50	381,30	457,60
	20/21	325,00	390,10	359,60	431,60	394,50	473,40
083	10/11	314,90	377,80	350,90	421,20	387,20	464,60
	15/16	327,50	392,90	365,20	438,20	402,60	483,00
	20/21	340,70	408,80	379,20	455,00	418,20	501,90
103	10/11	327,50	392,90	367,50	441,00	407,30	488,80
	15/16	341,60	409,90	382,40	459,00	423,90	508,70
	20/21	356,00	427,20	398,20	477,80	440,40	528,50
123	10/11	340,70	408,80	384,40	461,30	427,80	513,30
	15/16	356,40	427,60	400,60	480,70	445,40	534,50
	20/21	371,80	446,00	417,10	500,50	462,70	555,20
143	10/11	365,90	439,10	416,10	499,30	466,20	559,50
	15/16	383,60	460,30	434,60	521,50	486,00	583,40
	20/21	401,00	481,10	453,60	544,30	506,20	607,30
163	10/11	379,20	455,00	433,00	519,80	486,80	584,10
	15/16	398,20	477,80	452,80	543,30	507,60	609,10
	20/21	416,60	500,00	472,60	567,10	528,90	634,60

MAXI FF



Dostawa standardowa

- wstępnie złożona obudowa
- kolor 233 lub 001
- dostarczana w kartonowym opakowaniu, które może być użyte do zabezpieczenia na miejscu budowy po instalacji

KOD ZAMÓWIENIA

kod	wys.	dł.	typ	kolor	model	podł.
CMAW.	HHH	LLL	TT.	XXX/FF		/70

standardowe podłączenie prawe (/70)
podłączenie lewe (/20)
opcja pod wysoki zawór lewa (/30)
opcja pod wysoki zawór prawa (/60)
siłownik lub głowica zdalna (/00)

MAXI - WYMIENNIK CIEPŁA

STANDARD

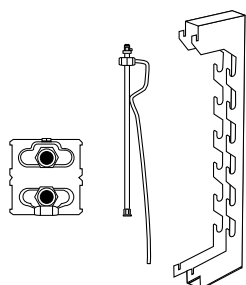

Dostawa standardowa

- wymiennik ciepła Low-H2O
- konsole ścienne
- przedłużony odpowietrznik
- zestaw montażowy
- korek

KOD ZAMÓWIENIA

kod	wys.	dł.	typ
HMAW.	HHH	LLL	TT

TWIN

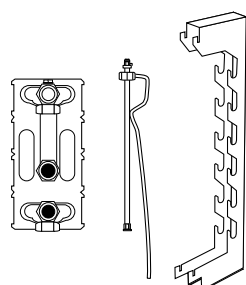

Dostawa standardowa

- wymiennik ciepła Low-H2O typu Twin
- konsole ścienne
- przedłużony odpowietrznik
- zestaw montażowy
- korek

KOD ZAMÓWIENIA

kod	wys.	dł.	typ
HMAW.	HHH	LLL	TT

L	STANDARD			TWIN				
	Typ	H 044	059	074	Typ	H 044	059	074
063	10	118,00	123,70	128,50	11	199,10	205,00	209,70
	15	141,00	146,90	152,00	16	239,90	245,70	250,80
	20	165,00	169,80	175,70	21	255,40	260,30	266,20
083	10	139,80	145,60	150,40	11	238,80	244,70	249,40
	15	171,70	177,70	182,70	16	295,50	301,40	306,40
	20	205,30	210,10	215,90	21	319,90	324,90	330,60
103	10	158,40	164,30	169,10	11	272,10	277,80	282,60
	15	198,50	204,40	209,60	16	344,10	350,00	355,00
	20	241,30	246,20	252,00	21	377,70	382,70	388,50
123	10	172,50	178,30	183,00	11	297,40	303,20	308,00
	15	219,90	225,80	230,90	16	382,20	388,20	393,20
	20	269,40	274,40	280,10	21	422,90	427,80	433,50
143	10	205,20	213,80	220,80	11	341,10	349,80	356,90
	15	259,80	268,70	276,20	16	438,80	447,60	455,40
	20	337,60	344,80	353,50	21	520,00	527,30	535,80
163	10	234,90	243,40	250,60	11	394,30	403,00	410,00
	15	302,60	311,50	319,20	16	515,60	524,50	532,00
	20	395,20	402,60	411,30	21	611,70	619,10	627,80

OPCJA DBE

Patrz zestawy DBE

MAXI - OPCJE

KRATKA PENCIL-PROOF

KOD ZAMÓWIENIA

kod	dł.	typ	kolor
5612. 000	LLL	TT	XXX /MAX

Dyskretnie umieszczona poniżej standardowej kratki. Opcjonalna kratka pencil-proof: zapobiega przedostaniu się małych elementów i odpadków do obudowy grzejnika. Lakierowana w kolorze obudowy. Tylko do Maxi WT i FT.

Współczynnik korekcyjny wydajności WT: 0.87

Współczynnik korekcyjny wydajności FT: 0.92



L	Typ		
	10/11	15/16	20/16
063	20,60	22,50	23,80
083	21,90	24,50	25,90
103	23,50	26,40	28,20
123	25,00	29,40	31,70
143	27,90	32,10	35,10
163	28,20	33,60	36,50

KRATKA DOLNA

KOD ZAMÓWIENIA

kod	dł.	typ	kolor
5613. 000	LLL	TT	XXX /MAX

Ostania obudowę grzejnika od dołu. Lakierowana w kolorze obudowy. Tylko do Maxi WF i WT.

Współczynnik korekcyjny wydajności WF: 0.92

Współczynnik korekcyjny wydajności WT: 0.87



L	Typ		
	10/11	15/16	20/16
063	27,30	29,40	30,70
083	28,90	31,20	32,70
103	30,20	33,30	35,10
123	32,10	36,50	39,10
143	36,10	40,80	43,50
163	37,10	42,00	44,90

ZABEZPIECZENIA OBUDOWY

2 sztuki na obudowę: powodują, że obudowa nie może być zdemontowana bez narzędzi. Do wszystkich modeli.



Kod		€
5111.010	2 sztuki	14,60

WKRETY ZABEZPIEZAJĄCE

100 sztuk wkretów: jako zamiennik dla zwykłych śrub. Wymaga specjalnego narzędzia (security torx bit).



Kod		€
5111.020	wkrety 100 szt.	172,70
5111.030	torx bit	45,00

KONSOLE ŚCIENNE - MINI

KONSOLE ŚCIENNE

Typ	kolor st.	inne
05/06	15,60	17,50
09/10/11	15,60	17,50
14/15/16	15,60	17,50
19/20/21	15,60	17,50

Typ 05/06



Typ 09/10/11



Typ 14/15/16



Typ 19/20/21

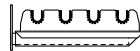

KOD ZAMÓWIENIA

kod typ kolor
5205. 000 000 TT. XXX /W

Ilość konsol na długość obudowy:
od 060 do 160 cm: min. 2 konsole
od 180 do 300 cm: min. 3 konsole

NÓŻKI - MINI

NÓŻKI STAŁE

Nóżka	H	Typ	kolor st.	inne
FS	6.5	05/06	15,60	17,50
	6.5	09/10/11	15,60	17,50
	6.5	14/15/16	15,60	17,50
	6.5	19/20/21	15,60	17,50
FM	10	05/06	15,60	17,50
	10	09/10/11	15,60	17,50
	10	14/15/16	15,60	17,50
	10	19/20/21	15,60	17,50
FL	12	05/06	15,60	17,50
	12	09/10/11	15,60	17,50
	12	14/15/16	15,60	17,50
	12	19/20/21	15,60	17,50

Typ 05/06

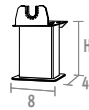

Typ 09/10/11

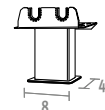

Typ 14/15/16

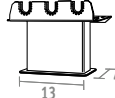

Typ 19/20/21

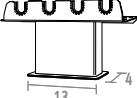

KOD ZAMÓWIENIA

kod typ kolor noga
5205. 000 000 TT. XXX /FS
wys. 6.5 cm: FS
wys. 10 cm: FM
wys. 12 cm: FL

Do montażu na wykończonej podłodze

Ilość nóżek na długość obudowy:
od L 060 do 160 cm: 2 nóżki
od L 180 do 300 cm: 3 nóżki

NÓŻKI REGULOWANE

Nóżka	H	Typ	kolor st.	inne
AS	13.5 > 21	05/06	44,80	50,20
	13.5 > 21	09/10/11	44,80	50,20
	13.5 > 21	14/15/16	44,80	50,20
	13.5 > 21	19/20/21	44,80	50,20
AL	21.5 > 34	05/06	44,80	50,20
	21.5 > 34	09/10/11	44,80	50,20
	21.5 > 34	14/15/16	44,80	50,20
	21.5 > 34	19/20/21	44,80	50,20

Typ 05/06 Typ 09/10/11 Typ 14/15/16 Typ 19/20/21

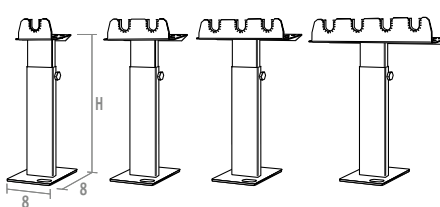

KOD ZAMÓWIENIA

kod typ kolor noga
5205. 000 000 TT. XXX /AS
wys. regulacji od 13.5 do 21 cm: AS
wys. regulacji od 21.5 do 34 cm: AL

Do montażu w podłogach betonowych i podniesionych

Ilość nóżek na długość obudowy:
od L 060 do 160 cm: 2 nóżki
od L 180 do 300 cm: 3 nóżki

MINI-OBUDOWA



Dostawa standardowa

- jednoczęściowa obudowa
- kolor 133 lub 001
- dostarczana w opakowaniu kartonowym

KOD ZAMÓWIENIA

kod	wys.	dł.	typ	kolor
CMIN.	HHH	LLL	TT.	XXX

L	H 008			H 013			H 023			H 028		
	Typ	kolor st.	inne	Typ	kolor st.	inne	Typ	kolor st.	inne	Typ	kolor st.	inne
060	---	---	---	05	88,70	150,80	06	114,30	194,40	06	144,00	244,80
	09	85,60	145,40	10	96,00	163,20	11	121,70	207,00	11	152,90	260,00
	14	98,30	167,20	15	109,90	187,00	16	137,20	233,40	16	170,30	289,60
	19	103,20	175,60	20	115,30	196,00	21	142,60	242,30	21	177,10	301,20
070	---	---	---	05	90,60	154,00	06	116,20	197,60	06	146,10	248,40
	09	87,70	149,10	10	97,90	166,30	11	123,50	209,90	11	154,80	263,10
	14	100,40	170,60	15	112,00	190,40	16	139,10	236,50	16	173,50	294,80
	19	105,10	178,70	20	117,30	199,40	21	144,60	245,70	21	178,90	304,20
080	---	---	---	05	92,40	157,10	06	118,30	201,10	06	147,90	251,50
	09	89,50	152,10	10	99,80	169,70	11	125,60	213,50	11	156,70	266,40
	14	102,20	173,80	15	113,90	193,60	16	141,20	240,10	16	175,40	298,00
	19	107,10	182,20	20	119,10	202,40	21	146,40	249,00	21	182,10	309,40
090	---	---	---	05	94,50	160,70	06	120,40	204,60	06	150,80	256,40
	09	91,60	155,70	10	101,60	172,70	11	127,60	216,80	11	159,60	271,40
	14	104,20	177,10	15	115,90	197,00	16	143,20	243,40	16	177,10	301,20
	19	109,20	185,50	20	121,20	205,90	21	148,50	252,50	21	183,90	312,70
100	---	---	---	05	96,30	163,70	06	122,00	207,50	06	152,90	260,00
	09	93,50	158,90	10	103,60	176,20	11	129,60	220,30	11	161,70	275,00
	14	106,20	180,50	15	117,60	200,00	16	145,00	246,50	16	180,20	306,30
	19	110,90	188,60	20	123,20	209,40	21	150,50	255,90	21	185,90	315,90
110	---	---	---	05	100,40	170,60	06	127,90	217,50	06	159,60	271,40
	09	97,40	165,70	10	107,90	183,50	11	135,90	230,90	11	169,40	287,90
	14	110,60	188,00	15	122,70	208,60	16	151,90	258,30	16	187,70	319,20
	19	116,20	197,60	20	129,00	219,20	21	158,10	268,80	21	195,80	332,90
120	---	---	---	05	107,10	182,20	06	134,70	229,00	06	167,50	284,70
	09	103,60	176,20	10	115,30	196,00	11	143,20	243,40	11	177,10	301,20
	14	116,80	198,50	15	130,00	220,90	16	159,20	270,70	16	196,60	334,20
	19	123,20	209,40	20	136,80	232,70	21	166,10	282,50	21	204,40	347,60
140	---	---	---	05	116,80	198,50	06	149,40	254,00	06	184,90	314,40
	09	113,30	192,70	10	126,00	214,20	11	158,70	269,60	11	195,80	332,90
	14	127,60	216,80	15	141,60	240,90	16	175,80	298,80	16	215,90	367,00
	19	134,40	228,50	20	149,40	254,00	21	183,30	311,60	21	224,70	382,00
160	---	---	---	05	145,00	246,50	06	183,30	311,60	06	224,70	382,00
	09	139,50	237,30	10	155,20	264,00	11	193,70	329,30	11	237,50	403,70
	14	154,80	263,10	15	171,90	292,20	16	211,90	360,20	16	258,80	440,20
	19	162,50	276,30	20	180,50	306,80	21	220,30	374,50	21	268,70	456,80
180	---	---	---	05	161,70	275,00	06	205,00	348,40	06	250,10	425,30
	09	155,80	264,80	10	172,80	293,90	11	215,90	367,00	11	263,80	448,20
	14	170,90	290,50	15	189,80	322,70	16	234,70	399,00	16	285,20	484,90
	19	180,50	306,80	20	200,60	340,90	21	245,30	417,10	21	297,80	506,30
200	---	---	---	05	180,20	306,30	06	227,20	386,30	06	277,30	471,50
	09	173,50	294,80	10	192,70	327,70	11	240,00	408,00	11	292,00	496,40
	14	189,80	322,70	15	210,70	358,20	16	259,40	440,80	16	314,50	534,50
	19	199,40	339,00	20	221,70	376,70	21	270,30	459,40	21	327,10	556,10
220	---	---	---	05	220,90	375,60	06	273,10	464,30	06	331,00	562,60
	09	210,70	358,20	10	234,00	397,80	11	286,10	486,50	11	346,50	589,10
	14	227,70	387,20	15	253,20	430,30	16	306,60	521,20	16	370,80	630,30
	19	238,80	405,90	20	265,90	451,90	21	319,30	542,70	21	385,40	655,10
240	---	---	---	05	237,50	403,70	06	293,40	498,80	06	355,20	603,90
	09	226,40	384,80	10	251,70	427,90	11	307,40	522,70	11	371,80	632,00
	14	244,40	415,50	15	271,60	461,80	16	329,00	559,30	16	397,30	675,50
	19	256,40	436,00	20	285,20	484,90	21	342,60	582,50	21	412,70	701,50
260	---	---	---	05	252,00	428,40	06	311,90	530,10	06	376,80	640,70
	09	240,30	408,60	10	267,20	454,30	11	327,10	556,10	11	394,20	670,10
	14	259,40	440,80	15	288,10	489,70	16	349,50	594,10	16	421,40	716,30
	19	272,60	463,30	20	302,70	514,60	21	364,00	618,90	21	438,00	744,50

WYMIENNIK CIEPŁA - MINI

L	H 008		H 013		H 023 / 028	
	Typ	€	Typ	€	Typ	€
060	---	---	05	59,90	06	139,10
	09	59,90	10	79,90	11	161,10
	14	77,00	15	102,20	16	201,00
	19	93,90	20	125,20	21	215,60
070	---	---	05	71,00	06	161,70
	09	71,00	10	94,50	11	187,40
	14	91,60	15	122,00	16	237,50
	19	113,30	20	151,30	21	257,80
080	---	---	05	76,30	06	172,20
	09	76,30	10	101,60	11	200,70
	14	99,80	15	132,80	16	256,60
	19	124,10	20	165,40	21	280,10
090	---	---	05	80,70	06	181,00
	09	80,70	10	107,60	11	211,20
	14	107,10	15	142,60	16	274,70
	19	133,80	20	178,20	21	300,50
100	---	---	05	90,00	06	199,40
	09	90,00	10	120,40	11	233,80
	14	119,70	15	159,60	16	305,20
	19	151,30	20	201,50	21	337,90
110	---	---	05	95,30	06	210,30
	09	95,30	10	127,20	11	246,20
	14	127,90	15	170,90	16	324,00
	19	161,70	20	215,60	21	360,80
120	---	---	05	100,70	06	220,90
	09	100,70	10	134,40	11	259,40
	14	135,90	15	181,00	16	343,40
	19	172,20	20	229,60	21	383,00
140	---	---	05	110,90	06	241,50
	09	110,90	10	147,90	11	283,90
	14	151,30	15	201,50	16	380,50
	19	208,20	20	277,80	21	460,20
160	---	---	05	133,20	06	286,10
	09	133,20	10	177,70	11	337,20
	14	183,30	15	244,40	16	457,30
	19	251,70	20	335,40	21	552,00
180	---	---	05	144,60	06	308,60
	09	144,60	10	192,70	11	364,40
	14	200,60	15	267,20	16	498,40
	19	274,70	20	365,90	21	601,20
200	---	---	05	155,80	06	331,00
	09	155,80	10	207,80	11	391,50
	14	233,30	15	311,00	16	577,30
	19	297,30	20	396,60	21	650,20
220	---	---	05	182,10	06	383,60
	09	182,10	10	242,40	11	453,70
	14	272,10	15	362,60	16	670,10
	19	348,00	20	463,80	21	757,70
240	---	---	05	194,30	06	407,80
	09	194,30	10	258,80	11	483,50
	14	290,40	15	387,20	16	714,70
	19	373,20	20	497,40	21	811,50
260	---	---	05	207,50	06	434,30
	09	207,50	10	276,40	11	515,00
	14	310,20	15	413,10	16	761,40
	19	398,50	20	531,40	21	865,80

PODŁĄCZENIE PRZELOTOWE

Mini wys. 008

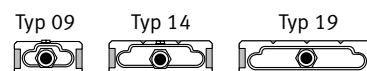

Dostawa standardowa

- wymiennik ciepła Low-H₂O typ 09, 14 lub 19
- odpowietrznik
- korek

KOD ZAMÓWIENIA

kod dt. typ
5004. 000 LLLL TT. /BS9

PODŁĄCZENIE JEDNOSTRONNE

Mini wys. 013

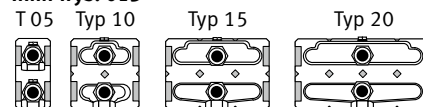

Mini wys. 023/028

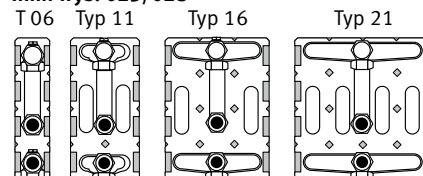

Dostawa standardowa

- wymiennik ciepła Low-H₂O
- odpowietrznik
- korek

KOD ZAMÓWIENIA

kod dt. typ
5003. 000 LLL TT. /BS9

OPCJA DBE

Patrz zestawy DBE

KNOCKONWOOD - OBUDOWA



Dostawa standardowa

- jednoczęściowa obudowa z drewnianym panelem czołowym i panelami bocznymi w kolorze sandblast grey (001)
- zaślepka w kolorze stali nierdzewnej do panelu bocznego
- dostarczana w kartonowym opakowaniu, które może być użyte do zabezpieczenia na miejscu budowy po instalacji

KOD ZAMÓWIENIA

<i>kod</i>	<i>wys.</i>	<i>dł.</i>	<i>typ</i>	<i>kolor</i>
CKNW.	HHH	LLL	TT.	XXX

L	Typ	H 030		H 055		H 080	
		kat. 1	kat. 2	kat. 1	kat. 2	kat. 1	kat. 2
060	06	447,10	511,20	484,60	553,70	522,70	596,60
	10/11	453,00	517,80	493,50	562,90	533,80	608,10
	15/16	464,50	530,00	509,10	579,50	554,30	629,70
080	06	483,20	552,20	530,80	606,20	586,50	669,60
	10/11	490,10	559,90	540,30	616,40	600,00	683,60
	15/16	503,70	574,60	558,10	635,10	626,50	712,10
100	06	539,30	615,90	617,30	705,20	705,90	806,20
	10/11	564,10	644,10	629,20	717,90	720,70	821,90
	15/16	579,80	661,70	653,90	745,00	751,90	855,80
120	06	653,20	746,60	733,50	838,10	834,30	953,40
	10/11	663,20	757,70	747,20	852,90	849,80	969,80
	15/16	679,70	775,80	774,00	882,30	882,20	1005,00
140	06	712,40	814,10	817,00	933,60	---	---
	10/11	722,80	825,80	832,10	950,30	---	---
	15/16	741,70	846,80	861,40	982,20	---	---
180	06	747,50	853,30	884,20	1009,80	---	---
	10/11	761,40	868,90	900,90	1028,00	---	---
	15/16	792,00	903,30	933,70	1064,50	---	---
220	06	849,60	969,60	1010,00	1153,30	---	---
	10/11	865,10	987,10	1027,70	1172,90	---	---
	15/16	900,40	1026,90	1065,30	1214,60	---	---

RODZAJE DREWNA

Kategoria 1



Kategoria 2



Certyfikat tylko dla:
dąb naturalny,
buk naturalny,
klon naturalny,
dąb bielony,
buk bielony,
mahoń

WYMIENNIK CIEPŁA - KNOCKONWOOD

L	STANDARD				TWIN			
	Typ	H 030	055	080	Typ	H 030	055	080
060	---	---	---	---	06	159,00	174,20	180,80
	10	105,70	117,20	125,30	11	182,90	198,20	206,40
	15	130,10	140,50	151,20	16	224,80	238,90	250,00
080	---	---	---	---	06	191,90	207,40	213,90
	10	127,70	139,00	147,20	11	222,60	237,80	246,10
	15	160,80	171,20	182,00	16	280,40	294,60	305,70
100	---	---	---	---	06	219,20	234,50	241,10
	10	146,30	157,70	165,80	11	255,90	271,00	279,40
	15	187,50	197,80	208,60	16	329,10	343,20	354,30
120	---	---	---	---	06	240,80	256,10	262,60
	10	160,40	171,80	179,90	11	281,40	296,40	304,70
	15	209,00	219,20	230,00	16	367,30	381,40	392,30
140	---	---	---	---	06	270,30	290,90	---
	10	184,20	200,60	---	11	315,80	336,10	---
	15	240,50	255,40	---	16	415,30	434,20	---
180	---	---	---	---	06	337,40	357,80	---
	10	228,90	245,30	---	11	396,40	416,60	---
	15	306,20	321,20	---	16	533,30	552,00	---
220	---	---	---	---	06	412,20	432,80	---
	10	278,50	294,90	---	11	485,70	506,10	---
	15	401,40	416,40	---	16	705,10	723,80	---

STANDARD

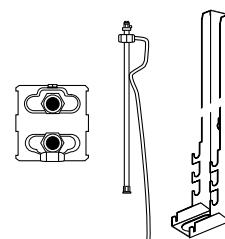

Dostawa standardowa

- wymiennik ciepła Low-H₂O
- konsole ścienne
- przedłużony odpowietrznik
- zestaw montażowy
- korek

KOD ZAMÓWIENIA

kod	wys.	dł.	typ
HKNW.	HHH	LLL	TT

TWIN

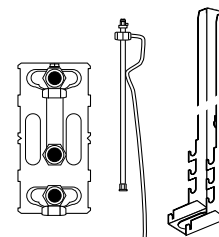

Dostawa standardowa

- wymiennik ciepła Low-H₂O typu Twin
- konsole ścienne
- przedłużony odpowietrznik
- zestaw montażowy
- korek

KOD ZAMÓWIENIA

kod	wys.	dł.	typ
HKNW.	HHH	LLL	TT

OPCJA DBE

Patrz zestawy DBE

LINEA PLUS STOJĄCA - OBUDOWA



L	Typ	H 020		H 035	
		kolor st.	inne	kolor st.	inne
050	10/11	77,90	133,10	92,80	158,60
	15/16	90,20	153,80	106,60	181,70
060	10/11	82,80	141,00	100,60	171,50
	15/16	94,90	161,70	114,20	194,80
070	10/11	86,70	147,70	105,60	180,30
	15/16	99,80	169,90	120,30	205,10
080	10/11	94,10	160,20	115,00	195,50
	15/16	107,60	183,30	130,00	221,20
090	10/11	100,20	170,70	125,20	213,00
	15/16	113,80	193,90	140,40	238,70
100	10/11	103,80	176,70	129,50	220,30
	15/16	117,80	200,80	145,10	246,90
110	10/11	108,30	184,50	136,10	231,40
	15/16	122,70	209,30	152,00	258,80
120	10/11	115,30	196,60	143,10	243,90
	15/16	129,90	221,30	159,20	271,20
140	10/11	126,00	214,80	158,80	270,00
	15/16	141,50	241,30	175,80	299,10
160	10/11	155,30	264,40	193,70	329,50
	15/16	171,90	292,50	211,70	360,30
180	10/11	172,80	294,40	216,00	367,80
	15/16	189,70	323,30	234,50	399,30
200	10/11	192,70	328,10	239,90	408,10
	15/16	210,70	358,70	259,40	441,20
220	10/11	234,20	398,40	286,20	486,80
	15/16	253,10	430,60	306,60	521,60
240	10/11	251,60	428,30	307,40	523,10
	15/16	271,40	462,40	328,90	559,80
260	10/11	267,40	455,00	327,00	556,20
	15/16	288,10	490,20	349,30	594,00
280	10/11	282,20	480,00	346,20	589,10
	15/16	303,60	516,30	368,90	628,00

Dostawa standardowa

- częściowo zmontowana obudowa do podłączenia z lewej lub prawej strony
- kolor 133 lub 001
- standardowe regulowane nóżki w kolorze szarym
- dostarczana w kartonowym opakowaniu, które może być użyte do zabezpieczenia na miejscu budowy po instalacji

KOD ZAMÓWIENIA

kod	wys.	dł.	typ	kolor
CLIF.	HHH	LLL	TT.	XXX

WYMIENNIK CIEPŁA - LINEA PLUS STOJĄCA

L	STANDARD		TWIN		
	Typ	H 020	035	Typ	035
050	10	111,80	116,80	11	197,60
	15	133,50	138,20	16	234,40
060	10	117,80	122,70	11	207,80
	15	142,10	146,90	16	249,80
070	10	132,30	137,20	11	234,20
	15	162,10	166,80	16	286,30
080	10	139,50	144,60	11	247,50
	15	172,80	177,70	16	305,40
090	10	145,60	150,50	11	257,90
	15	182,60	187,30	16	323,50
100	10	158,20	163,30	11	280,70
	15	199,70	204,40	16	354,20
110	10	165,10	169,90	11	293,10
	15	210,80	215,60	16	372,90
120	10	191,40	198,80	11	329,40
	15	241,00	248,10	16	416,60
140	10	205,00	212,30	11	354,20
	15	261,60	268,70	16	453,70
160	10	234,50	242,00	11	407,30
	15	304,50	311,50	16	530,60
180	10	249,70	257,00	11	434,60
	15	327,20	334,40	16	571,60
200	10	264,70	272,20	11	461,60
	15	371,00	378,00	16	650,50
220	10	299,40	306,60	11	524,00
	15	422,60	429,70	16	743,40
240	10	334,80	344,60	11	577,10
	15	467,40	476,80	16	812,30
260	10	352,40	362,10	11	608,70
	15	493,30	502,70	16	859,00
280	10	368,90	378,80	11	638,40
	15	518,00	527,40	16	903,50

STANDARD

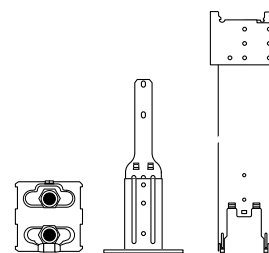

Dostawa standardowa

- wymiennik ciepła Low-H₂O
- konsole
- standardowe nóżki w kolorze szarym
- odpowietrznik kolankowy
- korek

KOD ZAMÓWIENIA

kod	wys.	dł.	typ
HLIF.	HHH	LLL	TT

TWIN

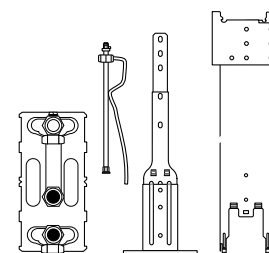

Dostawa standardowa

- wymiennik ciepła Low-H₂O typu Twin
- konsole
- standardowe nóżki w kolorze szarym
- odpowietrznik kolankowy
- korek

KOD ZAMÓWIENIA

kod	wys.	dł.	typ
HLIF.	HHH	LLL	TT

TEMPO STOJĄCY - OBUDOWA



Dostawa standardowa

- zestaw zawierający:
 - kratkę
 - 2 panele czotowe
 - panel boczny z otworem na głowicę termostatyczną
 - zamknięty panel boczny
- kolor 101
- kompaktowe opakowanie z kartonowymi zabezpieczeniami narożników

KOD ZAMÓWIENIA

kod	wys.	dł.	typ	kolor
CTEF.	HHH	LLL	TT.	101

		H 020	H 030	H 040	H 050
L	Typ				
040	10/11	51,20	63,40	75,20	88,80
	15/16	55,50	67,80	80,50	94,70
	20/21	60,40	72,60	86,40	101,00
050	10/11	54,80	67,80	80,50	94,90
	15/16	59,20	72,20	85,90	100,80
	20/21	64,20	77,30	91,80	107,30
060	10/11	59,30	74,40	89,00	105,50
	15/16	64,40	79,50	95,00	112,00
	20/21	69,70	84,70	101,40	118,90
070	10/11	65,90	83,10	99,40	117,80
	15/16	71,90	88,80	106,30	125,20
	20/21	77,70	94,70	113,10	132,50
080	10/11	69,10	87,00	104,50	123,90
	15/16	75,50	93,50	111,80	131,80
	20/21	81,80	99,80	119,30	139,50
090	10/11	74,80	94,60	113,90	135,10
	15/16	81,20	100,90	121,30	143,10
	20/21	88,40	108,30	129,60	151,90
100	10/11	80,90	102,70	124,00	147,30
	15/16	87,60	109,40	131,80	155,60
	20/21	95,30	117,20	140,60	165,00
110	10/11	86,30	110,10	133,70	159,00
	15/16	94,60	118,40	142,90	168,80
	20/21	101,90	125,70	151,20	177,70
120	10/11	89,00	113,70	138,10	164,10
	15/16	97,70	122,50	147,70	174,40
	20/21	106,10	130,80	157,00	184,30
140	10/11	103,00	132,80	162,20	193,50
	15/16	112,40	142,10	172,50	204,20
	20/21	121,60	151,30	182,70	215,00
160	10/11	114,10	146,90	179,00	213,30
	15/16	125,40	158,10	191,40	226,10
	20/21	136,90	169,70	203,80	239,00
180	10/11	124,40	161,00	196,90	234,70
	15/16	136,70	173,30	210,10	248,40
	20/21	148,70	185,20	223,10	262,10
200	10/11	138,70	180,20	220,80	263,80
	15/16	152,40	193,70	235,60	278,80
	20/21	165,60	206,90	249,70	293,60
220	10/11	151,90	196,10	239,90	285,40
	15/16	167,40	211,60	256,30	302,50
	20/21	182,50	226,70	272,60	319,20
240	10/11	163,40	211,70	259,60	309,20
	15/16	180,00	228,30	277,10	327,20
	20/21	195,40	243,70	293,60	344,30
260	10/11	172,90	224,20	274,90	327,50
	15/16	191,10	242,20	293,90	347,00
	20/21	208,00	259,20	312,10	365,60
280	10/11	190,80	246,80	302,20	359,40
	15/16	209,90	265,90	322,10	380,00
	20/21	227,20	283,10	340,50	398,90
300	10/11	199,40	258,30	316,70	376,80
	15/16	219,50	278,10	337,60	398,40
	20/21	237,90	296,70	357,00	418,30

WYMIENNIK CIEPŁA - TEMPO STOJĄCY

L	STANDARD				TWIN				
	Typ	H 020	030	040	050	Typ	030	040	050
040	10	102,20	103,20	104,20	105,10	11	178,30	179,10	180,20
	15	119,40	120,40	123,20	125,20	16	208,10	211,20	213,00
	20	136,90	137,90	140,70	143,70	21	217,20	220,00	222,80
050	10	108,90	109,90	111,00	111,80	11	190,90	191,70	192,70
	15	129,60	130,40	133,50	135,10	16	226,50	229,40	231,30
	20	150,00	150,80	153,70	156,80	21	238,10	241,00	243,90
060	10	115,00	115,90	117,00	117,80	11	201,00	201,90	203,00
	15	138,40	139,20	142,10	144,00	16	241,80	245,00	246,90
	20	162,20	163,00	165,90	169,10	21	257,50	260,30	263,20
070	10	129,60	130,40	131,60	132,30	11	227,40	228,40	229,30
	15	158,10	159,20	162,10	163,90	16	278,30	281,40	283,20
	20	188,40	189,30	192,20	195,30	21	299,70	302,50	305,40
080	10	136,80	137,90	138,80	139,50	11	240,70	241,50	242,60
	15	169,10	169,90	172,80	174,60	16	297,40	300,50	302,40
	20	202,70	203,40	206,30	209,30	21	322,00	324,90	327,90
090	10	142,80	143,70	144,80	145,60	11	251,30	252,00	253,10
	15	178,60	179,80	182,60	184,50	16	315,40	318,50	320,30
	20	215,30	216,10	219,00	222,10	21	342,30	345,20	348,10
100	10	155,50	156,50	157,40	158,20	11	273,80	274,80	275,70
	15	195,80	196,80	199,70	201,50	16	346,20	349,10	351,00
	20	238,60	239,50	242,40	245,40	21	379,80	382,70	385,70
110	10	162,20	163,30	164,30	165,10	11	286,30	287,10	288,10
	15	207,00	207,90	210,80	212,60	16	365,00	368,00	369,90
	20	252,70	253,60	256,40	259,60	21	402,60	405,40	408,20
120	10	169,50	170,50	171,60	172,30	11	299,40	300,20	301,20
	15	217,20	218,10	220,90	222,80	16	384,20	387,20	389,20
	20	266,70	267,60	270,60	273,50	21	424,90	427,80	430,60
140	10	200,70	202,10	203,60	205,00	11	344,00	345,20	346,70
	15	255,70	257,30	261,60	264,30	16	441,70	446,40	449,20
	20	333,50	334,80	339,00	343,60	21	522,90	527,30	531,60
160	10	230,20	231,70	233,30	234,50	11	397,10	398,40	399,90
	15	298,50	300,10	304,50	307,20	16	518,50	523,10	525,90
	20	391,00	392,30	396,70	401,20	21	614,90	619,10	623,50
180	10	245,30	246,90	248,40	249,70	11	424,30	425,70	427,20
	15	321,50	323,10	327,20	330,10	16	559,80	564,40	567,10
	20	421,60	422,90	427,20	431,90	21	664,00	668,30	672,60
200	10	260,50	262,00	263,60	264,70	11	451,50	452,80	454,30
	15	365,20	366,70	371,00	373,80	16	638,60	643,20	646,00
	20	452,20	453,60	457,90	462,50	21	713,00	717,30	721,60
220	10	294,90	296,40	298,10	299,40	11	513,80	515,00	516,50
	15	416,60	418,30	422,60	425,40	16	731,40	736,10	738,80
	20	519,50	520,80	525,20	529,70	21	820,40	824,70	829,10
240	10	329,00	331,00	333,10	334,80	11	563,50	565,20	567,20
	15	459,40	461,50	467,40	471,00	16	796,40	802,60	806,30
	20	571,50	573,30	579,00	585,10	21	895,20	901,00	906,80
260	10	346,60	348,70	350,60	352,40	11	595,00	596,80	598,90
	15	485,40	487,50	493,30	497,00	16	842,90	849,10	852,80
	20	605,60	607,20	613,10	619,10	21	949,50	955,30	961,00
280	10	363,30	365,30	367,40	368,90	11	624,80	626,40	628,40
	15	510,10	512,20	518,00	521,60	16	887,60	893,70	897,40
	20	639,30	641,00	646,70	652,90	21	1003,30	1009,20	1014,80
300	10	379,70	381,70	383,80	385,40	11	654,60	656,30	658,40
	15	534,60	536,60	542,30	546,10	16	931,20	937,40	941,20
	20	672,30	674,10	679,90	685,90	21	1056,20	1062,10	1067,70

STANDARD

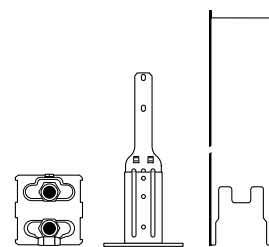

Dostawa standardowa

- wymiennik ciepła Low-H₂O
- konsole
- standardowe nóżki w kolorze szarym
- odpowietrznik kolankowy
- korek

KOD ZAMÓWIENIA

kod	wys.	dł.	typ
HTEF.	HHH	LLL	TT

TWIN

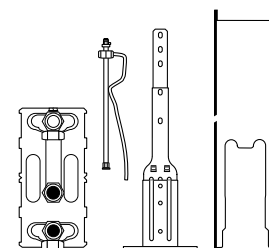

Dostawa standardowa

- wymiennik ciepła Low-H₂O typu Twin
- konsole
- standardowe nóżki w kolorze szarym
- odpowietrznik kolankowy
- korek

KOD ZAMÓWIENIA

kod	wys.	dł.	typ
HTEF.	HHH	LLL	TT

MINI CANAL - KOMPLETNA JEDNOSTKA BEZ KRATKI



Dostawa standardowa

Zmontowana jednostka Mini Canal, lakierowana na kolor szary :

- wymiennik ciepła Low-H₂O
- taśmy kotwiące
- odpowietrznik 1/8" i korek 1/2"
- anodowana ramka "L" lub "Z"

KOD ZAMÓWIENIA Z RAMKĄ "L"



kod	wys.	dł.	szer.	kolor
MICL.	HHH	LLL	BB	XXX
aluminium naturalne: FNA				
aluminium czarne: FBL				
aluminium ciemny brąz: FDB				
aluminium mosiądz: FBR				
lakierowana: FNC/XXX				

W celu uzyskania odpornej na ścieranie i promieniowanie UV powłoki, lakierujemy kratki najwyższej jakości lakierem poliesterowym. Tylko połysk (kod 2..)

KOD ZAMÓWIENIA Z RAMKĄ "Z"



kod	wys.	dł.	szer.	kolor
MICZ.	HHH	LLL	BB	XXX
aluminium naturalne: FNA				
aluminium czarne: FBL				
aluminium ciemny brąz: FDB				
aluminium mosiądz: FBR				
lakierowana: FNC/XXX				

Ramka przykrywająca "Z" zapewnia doskonałe wykończenie w przypadku remontowanych i drewnianych podłóg.

Wymiar kratki =
wymiar koryta - 1.2 cm

L	B	H 009	H 011	H 014	H 019
110	14	279,40	283,10	307,90	---
	18	283,80	287,00	---	---
	26	308,20	314,10	352,20	368,00
	34	348,20	354,10	402,90	418,50
	42	389,20	395,60	455,70	472,10
130	14	316,50	321,00	348,50	---
	18	322,10	326,00	---	---
	26	348,70	355,50	398,50	417,40
	34	395,50	402,90	458,60	478,00
	42	443,40	450,70	520,10	539,90
150	14	339,90	344,80	375,10	---
	18	346,40	351,30	---	---
	26	375,60	383,60	431,40	453,40
	34	429,70	438,10	500,00	522,40
	42	501,30	509,00	592,40	615,20
170	14	392,00	397,70	432,80	---
	18	400,40	405,30	---	---
	26	433,00	442,50	498,50	523,80
	34	499,50	508,40	583,30	608,60
	42	584,00	593,10	692,90	718,20
190	14	415,90	422,80	461,30	---
	18	425,90	431,90	---	---
	26	461,50	471,20	533,00	560,70
	34	535,30	544,80	627,10	655,30
	42	627,20	637,50	746,20	774,90
210	14	452,30	459,80	501,70	---
	18	463,90	470,10	---	---
	26	501,50	512,50	579,50	610,60
	34	600,00	611,10	705,80	737,90
	42	682,30	693,90	812,60	844,50
230	14	490,80	498,80	545,80	---
	18	506,30	512,40	---	---
	26	546,20	557,70	634,50	669,10
	34	658,50	670,80	780,70	815,20
	42	755,40	767,70	905,40	940,50
250	14	516,60	525,70	575,90	---
	18	533,90	541,20	---	---
	26	575,90	588,60	671,50	708,30
	34	696,90	710,00	827,70	865,10
	42	802,10	815,30	963,00	1000,90
270	14	542,00	552,20	605,60	---
	18	561,20	569,20	---	---
	26	605,10	619,40	707,50	747,70
	34	734,90	748,40	874,70	915,00
	42	847,20	861,40	1019,60	1060,40
290	14	587,10	597,20	654,60	---
	18	605,90	614,10	---	---
	26	654,60	669,40	762,90	806,30
	34	791,20	806,70	940,10	984,30
	42	912,70	928,30	1096,10	1141,10
310	14	614,60	625,60	686,20	---
	18	635,00	643,90	---	---
	26	686,00	701,90	798,70	845,10
	34	834,00	850,50	985,40	1032,30
	42	968,30	984,90	1152,30	1199,90
330	14	642,80	655,10	718,70	---
	18	665,30	674,90	---	---
	26	718,30	735,20	835,00	884,10
	34	873,20	890,40	1035,00	1085,20
	42	1028,30	1045,80	1211,50	1262,20
370	14	709,50	723,20	793,60	---
	18	735,40	746,00	---	---
	26	793,20	812,10	921,10	977,00
	34	965,50	985,20	1142,60	1199,20
	42	1140,10	1160,00	1340,10	1397,00

KOD ZAMÓWIENIA

kod dt. szer. kratka
GRIL. LLL.L BB.B /XXX

Kody kratek patrz w sekcji Kratki

KRATKI - MINI CANAL

L	B	DMN		RON		DMV		ROV		RNA		DBL		RBL		SBL		SNC/XXX	DNC/XXX
		DON	DBN	RMN	RBN	DOV	DBV	RMV	RBV	DNA	DDB	RDB	SDB	SBR	ANA	RSS			
108.8	12.8	116,74	55,16	66,69	153,41	83,01	102,16	138,39	146,55	146,55	78,66	92,04	160,04	452,39	96,83	176,80			
	16.8	125,12	57,99	71,48	169,18	91,72	112,72	146,99	156,13	156,13	95,42	113,59	189,64	503,09	118,37	188,55			
	24.8	142,53	65,17	81,49	196,93	114,78	131,21	165,27	175,28	175,28	128,82	155,80	248,72	572,94	161,79	211,51			
	32.8	160,26	71,48	91,72	236,64	124,36	157,76	224,02	237,18	237,18	161,79	197,80	307,14	712,20	204,11	286,91			
	40.8	177,78	78,23	101,73	275,92	143,94	183,98	241,54	255,90	255,90	195,19	240,77	365,02	932,96	247,96	308,88			
128.8	12.8	138,20	65,30	78,95	181,61	98,27	120,94	163,83	173,49	173,49	93,12	108,96	189,46	535,55	114,63	209,30			
	16.8	148,12	68,65	84,62	200,28	108,58	133,44	174,01	184,83	184,83	112,96	134,47	224,50	595,57	140,13	223,21			
	24.8	168,73	77,15	96,47	233,13	135,88	155,33	195,65	207,50	207,50	152,50	184,44	294,44	678,26	191,53	250,39			
	32.8	189,72	84,62	108,58	280,14	147,22	186,76	265,20	280,78	280,78	191,53	234,16	363,60	843,12	241,63	339,65			
	40.8	210,46	92,61	120,43	326,64	170,40	217,80	285,94	302,94	302,94	231,07	285,03	432,12	1104,46	293,54	365,66			
148.8	12.8	159,66	75,44	91,21	209,81	113,53	139,72	189,27	200,43	200,43	107,58	125,88	218,88	618,71	132,43	241,80			
	16.8	171,12	79,31	97,76	231,38	125,44	154,16	201,03	213,53	213,53	130,50	155,35	259,36	688,05	161,89	257,87			
	24.8	194,93	89,13	111,45	269,33	156,98	179,45	226,03	239,72	239,72	176,18	213,08	340,16	783,58	221,27	289,27			
	32.8	219,18	97,76	125,44	323,64	170,08	215,76	306,38	324,38	324,38	221,27	270,52	420,06	974,04	279,15	392,39			
	40.8	243,14	106,99	139,13	377,36	196,86	251,62	330,34	349,98	349,98	266,95	329,29	499,22	1275,96	339,12	422,44			
168.8	12.8	181,12	85,58	103,47	238,01	128,79	158,50	214,71	227,37	227,37	122,04	142,80	248,30	701,87	150,23	274,30			
	16.8	194,12	89,97	110,90	262,48	142,30	174,88	228,05	242,23	242,23	148,04	176,23	294,22	780,53	183,65	292,53			
	24.8	221,13	101,11	126,43	305,53	178,08	203,57	256,41	271,94	271,94	199,86	241,72	385,88	888,90	251,01	328,15			
	32.8	248,64	110,90	142,30	367,14	192,94	244,76	347,56	367,98	367,98	251,01	306,88	476,52	1104,96	316,67	445,13			
	40.8	275,82	121,37	157,83	428,08	223,32	285,44	374,74	397,02	397,02	302,83	373,55	566,32	1447,46	384,70	479,22			
188.8	12.8	202,58	95,72	115,73	266,21	144,05	177,28	240,15	254,31	254,31	136,50	159,72	277,72	785,03	168,03	306,80			
	16.8	217,12	100,63	124,04	293,58	159,16	195,60	255,07	270,93	270,93	165,58	197,11	329,08	873,01	205,41	327,19			
	24.8	247,33	113,09	141,41	341,73	199,18	227,69	286,79	304,16	304,16	223,54	270,36	431,60	994,22	280,75	367,03			
	32.8	278,10	124,04	159,16	410,64	215,80	273,76	388,74	411,58	411,58	280,75	343,24	532,98	1235,88	354,19	497,87			
	40.8	308,50	135,75	176,53	478,80	249,78	319,26	419,14	444,06	444,06	338,71	417,81	633,42	1618,96	430,28	536,00			
208.8	12.8	224,04	105,86	127,99	294,41	159,31	196,06	265,59	281,25	281,25	150,96	176,64	307,14	868,19	185,83	339,30			
	16.8	240,12	111,29	137,18	324,68	176,02	216,32	282,09	299,63	299,63	183,12	217,99	363,94	965,49	227,17	361,85			
	24.8	273,53	125,07	156,39	377,93	220,28	251,81	317,17	336,38	336,38	247,22	299,00	477,32	1099,54	310,49	405,91			
	32.8	307,56	137,18	176,02	454,14	238,66	302,76	429,92	455,18	455,18	310,49	379,60	589,44	1366,80	391,71	550,61			
	40.8	341,18	150,13	195,23	529,52	276,24	353,08	463,54	491,10	491,10	374,59	462,07	700,52	1790,46	475,86	592,78			
228.8	12.8	245,50	116,00	140,25	322,61	174,57	214,84	291,03	308,19	308,19	165,42	193,56	336,56	951,35	203,63	371,80			
	16.8	263,12	121,95	150,32	355,78	192,88	237,04	309,11	328,33	328,33	200,66	238,87	398,80	1057,97	248,93	396,51			
	24.8	299,73	137,05	171,37	414,13	241,38	275,93	347,55	368,60	368,60	270,90	327,64	523,04	1204,86	340,23	444,79			
	32.8	337,02	150,32	192,88	497,64	261,52	331,76	471,10	498,78	498,78	340,23	415,96	645,90	1497,72	429,23	603,35			
	40.8	373,86	164,51	213,93	580,24	302,70	386,90	507,94	538,14	538,14	410,47	506,33	767,62	1961,96	521,44	649,56			
248.8	12.8	266,96	126,14	152,51	350,81	189,83	233,62	316,47	335,13	335,13	179,88	210,48	365,98	1034,51	221,43	404,30			
	16.8	286,12	132,61	163,46	386,88	209,74	257,76	336,13	357,03	357,03	218,20	259,75	433,66	1150,45	270,69	431,17			
	24.8	325,93	149,03	186,35	450,33	262,48	300,05	377,93	400,82	400,82	294,58	356,28	568,76	1310,18	369,97	483,67			
	32.8	366,48	163,46	209,74	541,14	284,38	360,76	512,28	542,38	542,38	369,97	452,32	702,36	1628,64	466,75	656,09			
	40.8	406,54	178,89	232,63	630,96	329,16	420,72	552,34	585,18	585,18	446,35	550,59	834,72	2133,46	567,02	706,34			
268.8	12.8	288,42	136,28	164,77	379,01	205,09	252,40	341,91	362,07	362,07	194,34	227,40	395,40	1117,67	239,23	436,80			
	16.8	309,12	143,27	176,60	417,98	226,60	278,48	363,15	385,73	385,73	235,74	280,63	468,52	1242,93	292,45	465,83			
	24.8	352,13	161,01	201,33	486,53	283,58	324,17	408,31	433,04	433,04	318,26	384,92	614,48	1415,50	399,71	522,55			
	32.8	395,94	176,60	226,60	584,64	307,24	389,76	553,46	585,98	585,98	399,71	488,68	758,82	1759,56	504,27	708,83			
	40.8	439,22	193,27	251,33	681,68	355,62	454,54	596,74	632,22	632,22	482,23	594,85	901,82	2304,96	612,60	763,12			
288.8	12.8	309,88	146,42	177,03	407,21	220,35	271,18	367,35	389,01	389,01	208,80	244,32	424,82	1200,83	257,03	469,30			
	16.8	332,12	153,93	189,74	449,08	243,46	299,20	390,17	414,43	414,43	253,28	301,51	503,38	1335,41	314,21	500,49			
	24.8	378,33	172,99	216,31	522,73	304,68	348,29	438,69	465,26	465,26	341,94	413,56	660,20	1520,82	429,45	561,43			
	32.8	425,40	189,74	243,46	628,14	330,10	418,76	594,64	629,58	629,58	429,45	525,04	815,28	1890,48	541,79	761,57			
	40.8	471,90	207,65	270,03	732,40	382,08	488,36	641,14	679,26	679,26	518,11	639,11	968,92	2476,46	658,18	819,90			
308.8	12.8	331,34	156,56	189,29	435,41	235,61	289,96	392,79	415,95	415,95	223,26	261,24	454,24	1283,99	274,83	501,80			
	16.8	355,12	164,59	202,88	480,18	260,32	319,92	417,19	443,13	443,13	270,82	322,39	538,24	1427,89	335,97	535,15			
	24.8	404,53	184,97	231,29	558,93	325,78	372,41	469,07	497,48	497,48	365,62	442,20	705,92	1626,14	459,19	600,31			
	32.8	454,86	202,88	260,32	671,64	352,96	447,76	635,82	673,18	673,18	459,19	561,40	871,74	2021,40	579,31	814,31			
	40.8	504,58	222,03	288,73	783,12	408,54	522,18	685,54	726,30	726,30	553,99	683,37	1036,02	2647,96	703,76	876,68			
328.8	12.8	352,80	166,70	201,55	463,61	250,87	308,74	418,23	442,89	442,89	237,72	278,16	483,66	1367,15	292,63	534,30			
	16.8	378,12	175,25	216,02	511,28	277,18	340,64	444,21	471,83	471,83	288,								

MINI CANAL DBE - KOMPLETNA JEDNOSTKA BEZ KRATKI



Zabudowa w otworze:
 Wysokość H + 1 cm
 Długość L + 0.5 cm
 Szerokość B + 0.5 cm

Dostawa standardowa

Zmontowana jednostka Mini Canal DBE, lakierowana na kolor szary :

- wymiennik ciepła Low-H₂O
- taśmy kotwiące
- odpowietrznik 1/8" i korek 1/2"
- anodowana ramka "L" lub "Z"

KOD ZAMÓWIENIA Z RAMKĄ "L"



kod	wys.	dł.	szer.	kolor
MDCL.	HHH	LLL	BB	XXX

aluminium naturalne: **FNA**
 aluminium czarne: **FBL**
 aluminium ciemny brąz: **FDB**
 aluminium mosiądz: **FBR**
 lakierowana: **FNC/XXX**

KOD ZAMÓWIENIA Z RAMKĄ "Z"



kod	wys.	dł.	szer.	kolor
MDCZ.	HHH	LLL	BB	XXX

aluminium naturalne: **FNA**
 aluminium czarne: **FBL**
 aluminium ciemny brąz: **FDB**
 aluminium mosiądz: **FBR**
 lakierowana: **FNC/XXX**

W celu uzyskania odpornej na ścieranie i promieniowanie UV powłoki, lakierujemy kratki najwyższej jakości lakierem poliesterowym. Tylko połysk (kod 2..)

Wymiar kratki =
 wymiar koryta - 1.2 cm

L	B	H 014
110	26	566,50
34		609,80
42		655,20
130	26	606,20
34		657,60
42		710,40
150	26	714,80
34		773,30
42		852,80
170	26	852,70
34		924,90
42		1019,10
190	26	882,10
34		962,60
42		1065,10
210	26	1002,30
34		1110,40
42		1202,00
230	26	1049,40
34		1174,50
42		1281,70
250	26	1161,50
34		1295,20
42		1411,40
270	26	1192,30
34		1335,40
42		1459,90
290	26	1320,20
34		1471,90
42		1605,90
310	26	1431,20
34		1591,10
42		1734,30

KOD ZAMÓWIENIA

kod dł. szer. kratka
 GRIL. LLL.L BB.B /XXX

Kody kratek patrz w sekcji Kratki

KRATKI - MINI CANAL DBE

L	B	DMN DON DBN	RMN	RON RBN	DMV DOV DBV	RMV	ROV RBV	RNA DNA	DBL DDB DBR	RBL RDB RBR	SNA	SBL SDB SBR	ANA	RSS	SNC/XXX	DNC/XXX
108.8	24.8	142,53	65,17	81,49	196,93	114,78	131,21	165,27	175,28	175,28	128,82	155,80	248,72	572,94	161,79	211,51
	32.8	160,26	71,48	91,72	236,64	124,36	157,76	224,02	237,18	237,18	161,79	197,80	307,14	712,20	204,11	286,91
	40.8	177,78	78,23	101,73	275,92	143,94	183,98	241,54	255,90	255,90	195,19	240,77	365,02	932,96	247,96	308,88
128.8	24.8	168,73	77,15	96,47	233,13	135,88	155,33	195,65	207,50	207,50	152,50	184,44	294,44	678,26	191,53	250,39
	32.8	189,72	84,62	108,58	280,14	147,22	186,76	265,20	280,78	280,78	191,53	234,16	363,60	843,12	241,63	339,65
	40.8	210,46	92,61	120,43	326,64	170,40	217,80	285,94	302,94	302,94	231,07	285,03	432,12	1104,46	293,54	365,66
148.8	24.8	194,93	89,13	111,45	269,33	156,98	179,45	226,03	239,72	239,72	176,18	213,08	340,16	783,58	221,27	289,27
	32.8	219,18	97,76	125,44	323,64	170,08	215,76	306,38	324,38	324,38	221,27	270,52	420,06	974,04	279,15	392,39
	40.8	243,14	106,99	139,13	377,36	196,86	251,62	330,34	349,98	349,98	266,95	329,29	499,22	1275,96	339,12	422,44
168.8	24.8	221,13	101,11	126,43	305,53	178,08	203,57	256,41	271,94	271,94	199,86	241,72	385,88	888,90	251,01	328,15
	32.8	248,64	110,90	142,30	367,14	192,94	244,76	347,56	367,98	367,98	251,01	306,88	476,52	1104,96	316,67	445,13
	40.8	275,82	121,37	157,83	428,08	223,32	285,44	374,74	397,02	397,02	302,83	373,55	566,32	1447,46	384,70	479,22
188.8	24.8	247,33	113,09	141,41	341,73	199,18	227,69	286,79	304,16	304,16	223,54	270,36	431,60	994,22	280,75	367,03
	32.8	278,10	124,04	159,16	410,64	215,80	273,76	388,74	411,58	411,58	280,75	343,24	532,98	1235,88	354,19	497,87
	40.8	308,50	135,75	176,53	478,80	249,78	319,26	419,14	444,06	444,06	338,71	417,81	633,42	1618,96	430,28	536,00
208.8	24.8	273,53	125,07	156,39	377,93	220,28	251,81	317,17	336,38	336,38	247,22	299,00	477,32	1099,54	310,49	405,91
	32.8	307,56	137,18	176,02	454,14	238,66	302,76	429,92	455,18	455,18	310,49	379,60	589,44	1366,80	391,71	550,61
	40.8	341,18	150,13	195,23	529,52	276,24	353,08	463,54	491,10	491,10	374,59	462,07	700,52	1790,46	475,86	592,78
228.8	24.8	299,73	137,05	171,37	414,13	241,38	275,93	347,55	368,60	368,60	270,90	327,64	523,04	1204,86	340,23	444,79
	32.8	337,02	150,32	192,88	497,64	261,52	331,76	471,10	498,78	498,78	340,23	415,96	645,90	1497,72	429,23	603,35
	40.8	373,86	164,51	213,93	580,24	302,70	386,90	507,94	538,14	538,14	410,47	506,33	767,62	1961,96	521,44	649,56
248.8	24.8	325,93	149,03	186,35	450,33	262,48	300,05	377,93	400,82	400,82	294,58	356,28	568,76	1310,18	369,97	483,67
	32.8	366,48	163,46	209,74	541,14	284,38	360,76	512,28	542,38	542,38	369,97	452,32	702,36	1628,64	466,75	656,09
	40.8	406,54	178,89	232,63	630,96	329,16	420,72	552,34	585,18	585,18	446,35	550,59	834,72	2133,46	567,02	706,34
268.8	24.8	352,13	161,01	201,33	486,53	283,58	324,17	408,31	433,04	433,04	318,26	384,92	614,48	1415,50	399,71	522,55
	32.8	395,94	176,60	226,60	584,64	307,24	389,76	553,46	585,98	585,98	399,71	488,68	758,82	1759,56	504,27	708,83
	40.8	439,22	193,27	251,33	681,68	355,62	454,54	596,74	632,22	632,22	482,23	594,85	901,82	2304,96	612,60	763,12
288.8	24.8	378,33	172,99	216,31	522,73	304,68	348,29	438,69	465,26	465,26	341,94	413,56	660,20	1520,82	429,45	561,43
	32.8	425,40	189,74	243,46	628,14	330,10	418,76	594,64	629,58	629,58	429,45	525,04	815,28	1890,48	541,79	761,57
	40.8	471,90	207,65	270,03	732,40	382,08	488,36	641,14	679,26	679,26	518,11	639,11	968,92	2476,46	658,18	819,90
308.8	24.8	404,53	184,97	231,29	558,93	325,78	372,41	469,07	497,48	497,48	365,62	442,20	705,92	1626,14	459,19	600,31
	32.8	454,86	202,88	260,32	671,64	352,96	447,76	635,82	673,18	673,18	459,19	561,40	871,74	2021,40	579,31	814,31
	40.8	504,58	222,03	288,73	783,12	408,54	522,18	685,54	726,30	726,30	553,99	683,37	1036,02	2647,96	703,76	876,68

CANAL COMPACT - KOMPLETNA JEDNOSTKA BEZ KRATKI



Zabudowa w otworze:
Wysokość H + 2 cm
Długość L + 2 cm
Szerokość B + 2 cm

Dostawa standardowa

- kompletnie zmontowane wodoodporne koryto poliestrowe ze zintegrowaną ramką aluminiową
- zintegrowana ramka
FNA: naturalne aluminium
FBL: czarne aluminium
- wymiennik ciepła Low-H₂O typ 15
- prosty odpowietrznik i korek
- nóżki i konsole
- czarna poliuretanowa ścianka
- płyta zabezpieczająca

KOD ZAMÓWIENIA R 1.5

kod wys. dł. szer. kolor
CC15. HHH. LLL BB XXX

aluminium naturalne: **FNA**
aluminium czarne: **FBL**

KOD ZAMÓWIENIA R 4.0

kod wys. dł. szer. kolor
CC40. HHH. LLL BB XXX

aluminium naturalne: **FNA**
aluminium czarne: **FBL**

R 1.5				R 4.0			
H	L	B	€	H	L	B	€
036	178	36	803,50	052	189	47	949,30
	198	36	882,90		209	47	1041,20
	218	36	983,40		229	47	1154,10
	238	36	1091,70		249	47	1274,70
	258	36	1173,00		269	47	1368,50
					289	47	1463,50
					309	47	1557,30
					329	47	1650,90

KOD ZAMÓWIENIA

kod dl. szer. kratka
 GRIL. LLL.L BB.B /XXX

Kody kratek patrz w sekcji Kratki

KRATKI - CANAL COMPACT

L	B	DMN DON DBN	RMN	RON RBN	DMV DOV DBV	RMV	ROV RBV	RNA DNA	DBL DDB	RBL RDB	SNA	SBL SDB	ANA	RSS	SNC/XXX	DNC/XXX
174.8	32.8	257,48	114,84	147,36	380,19	199,80	253,46	359,91	381,06	381,06	259,93	317,79	493,46	1144,24	327,92	460,95
194.8	32.8	286,94	127,98	164,22	423,69	222,66	282,46	401,09	424,66	424,66	289,67	354,15	549,92	1275,16	365,44	513,69
214.8	32.8	316,40	141,12	181,08	467,19	245,52	311,46	442,27	468,26	468,26	319,41	390,51	606,38	1406,08	402,96	566,43
234.8	32.8	345,86	154,26	197,94	510,69	268,38	340,46	483,45	511,86	511,86	349,15	426,87	662,84	1537,00	440,48	619,17
254.8	32.8	375,32	167,40	214,80	554,19	291,24	369,46	524,63	555,46	555,46	378,89	463,23	719,30	1667,92	478,00	671,91
274.8	32.8	404,78	180,54	231,66	597,69	314,10	398,46	565,81	599,06	599,06	408,63	499,59	775,76	1798,84	515,52	724,65
294.8	32.8	434,24	193,68	248,52	641,19	336,96	427,46	606,99	642,66	642,66	438,37	535,95	832,22	1929,76	553,04	777,39
314.8	32.8	463,70	206,82	265,38	684,69	359,82	456,46	648,17	686,26	686,26	468,11	572,31	888,68	2060,68	590,56	830,13

Canal Compact R 1.5

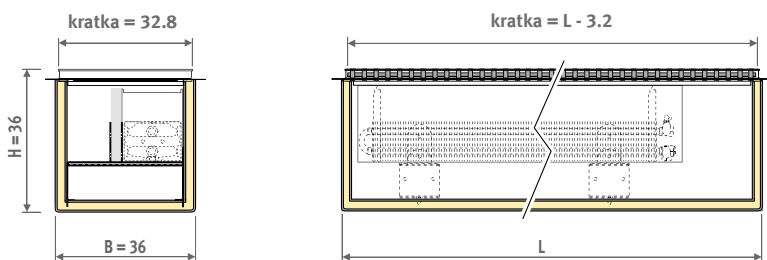

Canal Compact R 4.0

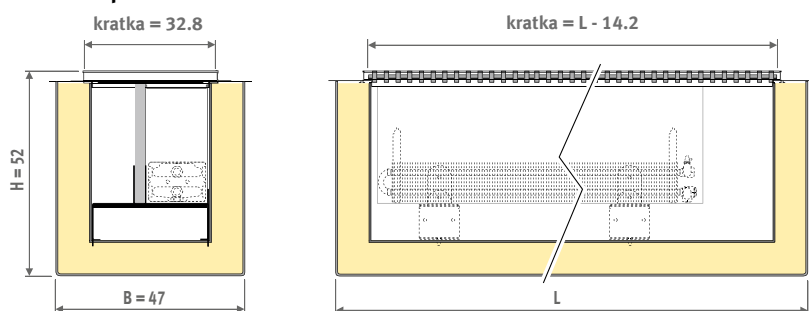

CANAL PLUS - KOMPLETNA JEDNOSTKA BEZ KRATKI



Zabudowa w otworze:
Wysokość H + 2 cm
Długość L + 2 cm
Szerokość B + 2 cm

Dostawa standardowa

- kompletnie zmontowane
- wodoodporne koryto poliestrowe ze zintegrowaną ramką aluminiową
- zintegrowana ramka
- FNA: naturalne aluminium
- FBL: czarne aluminium
- wymiennik ciepła Low-H₂O typ 15
- prosty odpowietrznik i korek
- nóżki i konsole
- czarna poliuretanowa ścianka
- płyta zabezpieczająca

KOD ZAMÓWIENIA

kod	wys.	dł.	szer.	kolor
CP25.	HHH	LLL	BB	/XXX
CP30.	HHH	LLL	BB	/XXX
CP40.	HHH	LLL	BB	/XXX

R 2.5				R 3.0				R 4.0			
H	L	B	€	H	L	B	€	H	L	B	€
068	121	35	574,10	069	123	37	612,30	072	129	43	694,90
		39	632,80			41	672,70			47	758,40
		51	718,20			53	761,70			59	855,20
131	35	613,70	133	37	654,60	139	43	742,20			
	39	678,30		41	720,80		47	811,50			
	51	769,50		53	816,20		59	915,20			
141	35	654,70	143	37	697,90	149	43	790,30			
	39	723,20		41	768,60		47	864,40			
	51	822,20		53	871,50		59	976,30			
161	35	734,10	163	37	782,70	169	43	884,80			
	39	812,10		41	862,90		47	968,70			
	51	945,30		53	1000,80		59	1116,40			
181	35	830,00	183	37	884,00	189	43	996,00			
	39	923,90		41	980,20		47	1096,10			
	51	1078,70		53	1140,10		59	1266,90			
201	35	911,10	203	37	970,20	209	43	1092,00			
	39	1015,00		41	1076,80		47	1203,10			
	51	1184,10		53	1251,70		59	1389,50			
221	35	992,60	223	37	1056,90	229	43	1188,50			
	39	1127,90		41	1195,00		47	1331,40			
	51	1290,80		53	1364,20		59	1513,10			
241	35	1093,10	243	37	1162,60	249	43	1304,00			
	39	1247,70		41	1320,40		47	1466,90			
	51	1432,90		53	1512,30		59	1672,20			
261	35	1175,90	263	37	1250,70	261	43	1402,00			
	39	1341,30		41	1419,50		47	1576,20			
	51	1542,20		53	1627,60		59	1798,70			
281	35	1285,40	283	37	1365,40	289	43	1526,40			
	39	1461,70		41	1545,20		47	1711,90			
	51	1677,30		53	1768,60		59	1950,80			
301	35	1368,50	303	37	1453,60	309	43	1624,60			
	39	1555,40		41	1644,40		47	1821,30			
	51	1786,80		53	1884,20		59	2077,30			
321	35	1450,80	323	37	1541,20	329	43	1721,80			
	39	1648,30		41	1742,70		47	1929,60			
	51	1894,80		53	1998,20		59	2202,50			

KOD ZAMÓWIENIA

GRIL. LLL.L BB.B /XXX

Kody kratki patrz w sekcji Kratki

KRATKI - CANAL PLUS

L	B	DMN	RON		DMV	ROV		RNA	DBL	RBL	SBL		RSS				DNC/XXX
		DON	RMN	RBN	DOV	RBV	DNA	DBB	RDB	SNA	SDB	ANA	SNC/XXX	DNC/XXX			
114.8	28.8	157,28	70,37	89,89	216,17	113,77	144,19	226,27	239,70	239,70	152,45	187,01	292,51	670,32	192,86	289,64	
	32.8	169,10	75,42	96,78	249,69	131,22	166,46	236,37	250,26	250,26	170,71	208,71	324,08	751,48	215,36	302,73	
	44.8	202,39	90,58	115,60	316,85	167,15	211,12	264,61	280,00	280,00	223,06	275,86	416,95	989,92	284,13	338,32	
124.8	28.8	170,98	76,50	97,72	235,00	123,68	156,75	245,98	260,58	260,58	165,73	203,30	317,99	728,71	209,66	314,87	
	32.8	183,83	81,99	105,21	271,44	142,65	180,96	256,96	272,06	272,06	185,58	226,89	352,31	816,94	234,12	329,10	
	44.8	220,02	98,47	125,67	344,45	181,71	229,51	287,66	304,39	304,39	242,49	299,89	453,27	1076,15	308,88	367,79	
134.8	28.8	184,68	82,63	105,55	253,83	133,59	169,31	265,69	281,46	281,46	179,01	219,59	343,47	787,10	226,46	340,10	
	32.8	198,56	88,56	113,64	293,19	154,08	195,46	277,55	293,86	293,86	200,45	245,07	380,54	882,40	252,88	355,47	
	44.8	237,65	106,36	135,74	372,05	196,27	247,90	310,71	328,78	328,78	261,92	323,92	489,59	1162,38	333,63	397,26	
154.8	28.8	212,08	94,89	121,21	291,49	153,41	194,43	305,11	323,22	323,22	205,57	252,17	394,43	903,88	260,06	390,56	
	32.8	228,02	101,70	130,50	336,69	176,94	224,46	318,73	337,46	337,46	230,19	281,43	437,00	1013,32	290,40	408,21	
	44.8	272,91	122,14	155,88	427,25	225,39	284,68	356,81	377,56	377,56	300,78	371,98	562,23	1334,84	383,13	456,20	
174.8	28.8	239,48	107,15	136,87	329,15	173,23	219,55	344,53	364,98	364,98	232,13	284,75	445,39	1020,66	293,66	441,02	
	32.8	257,48	114,84	147,36	380,19	199,80	253,46	359,91	381,06	381,06	259,93	317,79	493,46	1144,24	327,92	460,95	
	44.8	308,17	137,92	176,02	482,45	254,51	321,46	402,91	426,34	426,34	339,64	420,04	634,87	1507,30	432,63	515,14	
194.8	28.8	266,88	119,41	152,53	366,81	193,05	244,67	383,95	406,74	406,74	258,69	317,33	496,35	1137,44	327,26	491,48	
	32.8	286,94	127,98	164,22	423,69	222,66	282,46	401,09	424,66	424,66	289,67	354,15	549,92	1275,16	365,44	513,69	
	44.8	343,43	153,70	196,16	537,65	283,63	358,24	449,01	475,12	475,12	378,50	468,10	707,51	1679,76	482,13	574,08	
214.8	28.8	294,28	131,67	168,19	404,47	212,87	269,79	423,37	448,50	448,50	285,25	349,91	547,31	1254,22	360,86	541,94	
	32.8	316,40	141,12	181,08	467,19	245,52	311,46	442,27	468,26	468,26	319,41	390,51	606,38	1406,08	402,96	566,43	
	44.8	378,69	169,48	216,30	592,85	312,75	395,02	495,11	523,90	523,90	417,36	516,16	780,15	1852,22	531,63	633,02	
234.8	28.8	321,68	143,93	183,85	442,13	232,69	294,91	462,79	490,26	490,26	311,81	382,49	598,27	1371,00	394,46	592,40	
	32.8	345,86	154,26	197,94	510,69	268,38	340,46	483,45	511,86	511,86	349,15	426,87	662,84	1537,00	440,48	619,17	
	44.8	413,95	185,26	236,44	648,05	341,87	431,80	541,21	572,68	572,68	456,22	564,22	852,79	2024,68	581,13	691,96	
254.8	28.8	349,08	156,19	199,51	479,79	252,51	320,03	502,21	532,02	532,02	338,37	415,07	649,23	1487,78	428,06	642,86	
	32.8	375,32	167,40	214,80	554,19	291,24	369,46	524,63	555,46	555,46	378,89	463,23	719,30	1667,92	478,00	671,91	
	44.8	449,21	201,04	256,58	703,25	370,99	468,58	587,31	621,46	621,46	495,08	612,28	925,43	2197,14	630,63	750,90	
274.8	28.8	376,48	168,45	215,17	517,45	272,33	345,15	541,63	573,78	573,78	364,93	447,65	700,19	1604,56	461,66	693,32	
	32.8	404,78	180,54	231,66	597,69	314,10	398,46	565,81	599,06	599,06	408,63	499,59	775,76	1798,84	515,52	724,65	
	44.8	484,47	216,82	276,72	758,45	400,11	505,36	633,41	670,24	670,24	533,94	660,34	998,07	2369,60	680,13	809,84	
294.8	28.8	403,88	180,71	230,83	555,11	292,15	370,27	581,05	615,54	615,54	391,49	480,23	751,15	1721,34	495,26	743,78	
	32.8	434,24	193,68	248,52	641,19	336,96	427,46	606,99	642,66	642,66	438,37	535,95	832,22	1929,76	553,04	777,39	
	44.8	519,73	232,60	296,86	813,65	429,23	542,14	679,51	719,02	719,02	572,80	708,40	1070,71	2542,06	729,63	868,78	
314.8	28.8	431,28	192,97	246,49	592,77	311,97	395,39	620,47	657,30	657,30	418,05	512,81	802,11	1838,12	528,86	794,24	
	32.8	463,70	206,82	265,38	684,69	359,82	456,46	648,17	686,26	686,26	468,11	572,31	888,68	2060,68	590,56	830,13	
	44.8	554,99	248,38	317,00	868,85	458,35	578,92	725,61	767,80	767,80	611,66	756,46	1143,35	2714,52	779,13	927,72	

Canal Plus R 2.5

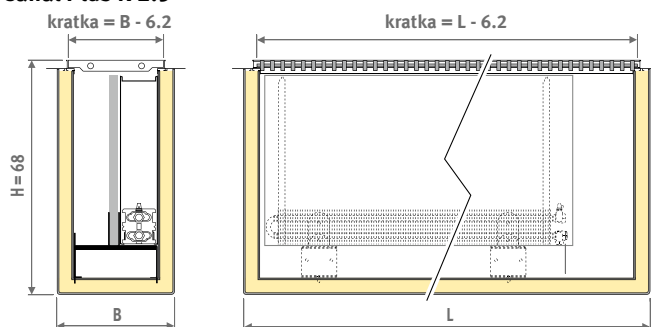

Canal Plus R 3.0

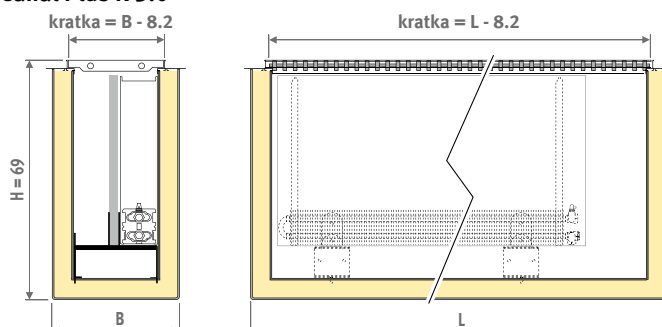

Canal Plus R 4.0

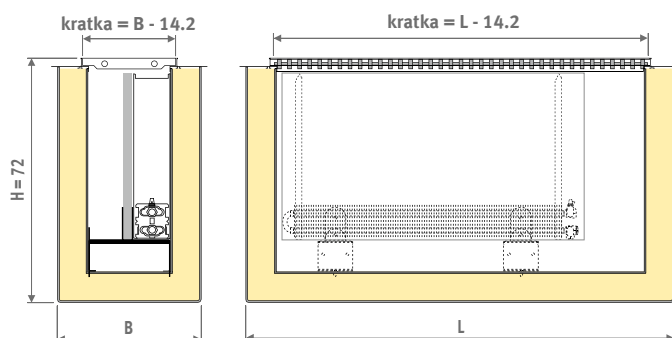

KRATKI

KOD ZAMÓWIENIA

kod dł. szer. kratka
 GRIL. LLL.L BB.B /XXX
 Kod kratki

€/METR

B	DMN DON DBN	RMN	RON RBN	DMV DOV DBV	RMV	ROV RBV	RNA DNA	DBL DDB DBR	RBL RDB RBR	SNA	SBL SDB SBR	RSS	SNC/XXX	DNC/XXX
12.8	107,30	50,70	61,30	141,00	76,30	93,90	127,20	134,70	134,70	72,30	84,60	415,80	89,00	162,50
16.8	115,00	53,30	65,70	155,50	84,30	103,60	135,10	143,50	143,50	87,70	104,40	462,40	108,80	173,30
24.8	131,00	59,90	74,90	181,00	105,50	120,60	151,90	161,10	161,10	118,40	143,20	526,60	148,70	194,40
28.8	137,00	61,30	78,30	188,30	99,10	125,60	197,10	208,80	208,80	132,80	162,90	583,90	168,00	252,30
32.8	147,30	65,70	84,30	217,50	114,30	145,00	205,90	218,00	218,00	148,70	181,80	654,60	187,60	263,70
36.8	155,10	68,10	88,70	235,20	122,70	156,70	214,30	226,80	226,80	164,30	201,50	696,50	208,10	274,20
40.8	163,40	71,90	93,50	253,60	132,30	169,10	222,00	235,20	235,20	179,40	221,30	857,50	227,90	283,90
44.8	176,30	78,90	100,70	276,00	145,60	183,90	230,50	243,90	243,90	194,30	240,30	862,30	247,50	294,70
48.8	190,90	85,20	109,20	288,30	151,90	192,20	275,90	292,50	292,50	210,30	259,20	933,00	268,10	353,10
52.8	207,00	91,90	118,30	324,00	170,30	215,90	284,20	301,40	301,40	225,80	279,50	1009,80	287,80	363,80
56.8	222,40	99,10	127,20	348,10	183,30	231,90	292,00	309,40	309,40	240,30	299,40	1068,90	307,20	373,60

! Podano wymiary w cm. Maksymalna długość kratki 6 m w 1 odcinku. Długość kratki = długość ramki - 1.2 cm.

Dane techniczne w dziale "Informacje Techniczne".

SZTYWNE KRATKI ALUMINIOWE DESIGNO



DNA kolor naturalny **DBL** czarna **DDB** ciemny brąz **DBR** mosiądz **DNC/XXX** lakierowana

SZTYWNE KRATKI ALUMINIOWE



SNA kolor naturalny **SBL** czarna **SDB** ciemny brąz **SBR** mosiądz **SNC/XXX** lakierowana

ZWIJANE KRATKI ALUMINIOWE



RNA kolor naturalny **RBL** czarna **RDB** ciemny brąz **RBR** mosiądz **RSS** stal nierdzewna

KRATKA STAL NIERDZEWNA

ZWIJANE KRATKI DREWNIANE DESIGNO



DMN merbau kolor naturalny **DMV** merbau lakierowany **DBN** buk kolor naturalny **DBV** buk lakierowany **DON** dąb kolor naturalny **DOV** dąb lakierowany

ZWIJANE KRATKI DREWNIANE



RMN merbau kolor naturalny **RMV** merbau lakierowany **RBN** buk kolor naturalny **RBV** buk lakierowany **RON** dąb kolor naturalny **ROV** dąb lakierowany

KRATKI

B	€/płytkę
24.8	302,80
28.8	335,80
32.8	376,30
40.8	493,15



PNC /026
odlew aluminium
platinum gray
RAL 9006

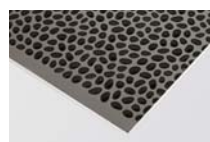

PNC /028
odlew aluminium
granite grey

PEBBLES

KOD ZAMÓWIENIA

kod	dł.	szer.	kratka
GRIL .	LLL.L	BB.B	PNC

Płytki o długości 50 cm.
Oznacz całkowitą długość kratki w kodzie zamówienia (np. 205.4 cm, ta kratka będzie składała się z 5 odcinków skróconych podczas produkcji)

Wymiar kratki = ramka -1.2 cm.

B	€/m
24.8	207,30
28.8	231,10
32.8	256,10
40.8	304,30
44.8	329,40

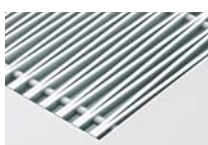

ANA
naturalny kolor alu

ACCORDION

KOD ZAMÓWIENIA

kod	dł.	szer.	kratka
GRIL .	LLL.L	BB.B	ANA

Długość dobierana indywidualnie:
Oznacz całkowitą długość kratki w kodzie zamówienia.
Długość do 1.70 m w jednym odcinku.
Dłuższe kratki dostarczane są w odcinkach.
Inne szerokości na zapytanie.

Wymiar kratki = ramka -1.2 cm.

RAMKI

B	€/m
14.0	40,50
18.0	40,80
26.0	41,90
30.0	42,30
34.0	42,80
38.0	43,50
42.0	43,50
46.0	44,20
50.0	44,90
54.0	45,30
58.0	45,30

RAMKA "L"

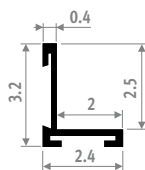

Ramka "L" z anodowanego aluminium.
Długość do 6 metrów w jednym odcinku.

RAMKA "Z"

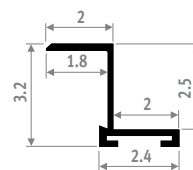

Ramka "Z" z anodowanego aluminium.
Długość do 6 metrów w jednym odcinku.

Mini Canal dostępny jest z ramkami o profilu "L" lub "Z". Canal Compact i Canal Plus dostępne są tylko z ramkami o profilu "L".

KOD ZAMÓWIENIA RAMKI "L"

kod	dł.	szer.	kolor
FRML .	LLL.L	BB.B	XXX

aluminium naturalne: **FNA**
aluminium czarne: **FBL**
aluminium ciemny brąz: **FDB**
aluminium mosiądz: **FBR**
lakierowana: **FNC/XXX**

KOD ZAMÓWIENIA RAMKI "Z"

kod	dł.	szer.	kolor
FRMZ .	LLL.L	BB.B	XXX

aluminium naturalne: **FNA**
aluminium czarne: **FBL**
aluminium ciemny brąz: **FDB**
aluminium mosiądz: **FBR**
lakierowana: **FNC/XXX**

W celu uzyskania odpornej na ścieranie i promieniowanie UV powłoki, lakierujemy kratki najwyższej jakości lakierem poliesterowym. Tylko połysk (kod 2..)

MOCOWANIA

KONFIGURACJA

Dodaj kod zamówienia odpowiedniego mocowania do kodu grzejnika.

- Wszystkie wyszczególnione elementy mocujące przyspawane są do grzejnika. Nie mogą one być zmienione później. Sprawdź dokładnie, czy wymagane opcje są zamawiane prawidłowo. Nieprawidłowe zlecenia nie mogą być zwrócone.

- Zamawiając grzejnik z opcjonalnymi mocowaniami (dolne, boczne i sufitowe) Standardowe mocowania ścienne nie są dostarczane. Jeśli dodasz KOD 9094.10 (bez dopłaty), standardowe mocowanie ścienne zostaną dostarczone oprócz opcjonalnych mocowań.

SANI RONDA / SANI PANEL / SANI LOUVRE

⚠ Mocowania zostaną dostarczone w kolorze grzejnika. Chrom tylko dla grzejnika Sani Ronda.

MOCOWANIA BOCZNE

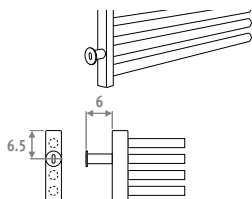

kolory standardowe: 233, 001

Kod	kolor	opis	€
9085.11	kolor st.	lewe górne	24,30
9085.11	inne	lewe górne	30,60
9085.11	chrom 009	lewe górne	50,70
9085.12	kolor st.	lewe dolne	24,30
9085.12	inne	lewe dolne	30,60
9085.12	chrom 009	lewe dolne	50,70
9085.21	kolor st.	prawe górne	24,30
9085.21	inne	prawe górne	30,60
9085.21	chrom 009	prawe górne	50,70
9085.22	kolor st.	prawe dolne	24,30
9085.22	inne	prawe dolne	30,60
9085.22	chrom 009	prawe dolne	50,70

STOPKI

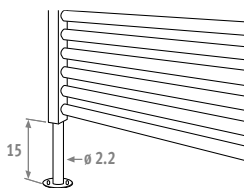

kolory standardowe: 233, 001

Kod	kolor	opis	€
9083.10	kolor st.	lewe	25,50
9083.10	inne	lewe	30,60
9083.10	chrom 009	lewe	50,70
9083.20	kolor st.	prawe	25,50
9083.20	inne	prawe	30,60
9083.20	chrom 009	prawe	50,70

Podłączenia 1-1 (lewe) lub 8-8 (prawe) nie są możliwe w przypadku zamówienia stoppek.

MOCOWANIA SUFITOWE

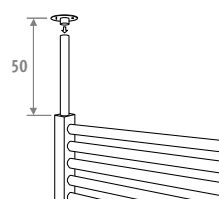

kolory standardowe: 233, 001

Kod	kolor	opis	€
9082.10	kolor st.	lewe	25,50
9082.10	inne	lewe	30,60
9082.10	chrom 009	lewe	50,70
9082.20	kolor st.	prawe	25,50
9082.20	inne	prawe	30,60
9082.20	chrom 009	prawe	50,70

Mocowanie ma 50 cm długości i może zostać skrócone podczas montażu.

DECO SPACE

⚠ Mocowania zostaną dostarczone w kolorze grzejnika.

MOCOWANIA BOCZNE

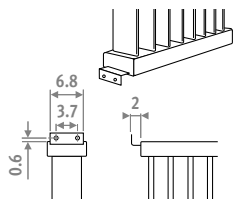

kolory standardowe: 233, 001

Kod	kolor	opis	€
9095.11	kolor st.	lewe górne	25,50
9095.11	inne	lewe górne	30,60
9095.12	kolor st.	lewe dolne	25,50
9095.12	inne	lewe dolne	30,60
9095.21	kolor st.	prawe górne	25,50
9095.21	inne	prawe górne	30,60
9095.22	kolor st.	prawe dolne	25,50
9095.22	inne	prawe dolne	30,60

Gdy zamawiane są mocowania boczne (podłączenia o kodzie 2, 3, 6, 7) są niemożliwe.

STOPKI

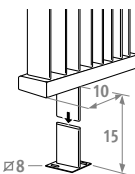

kolory standardowe: 233, 001

Kod	kolor	opis	€
9093.11	kolor st.	lewe	25,50
9093.11	inne	lewe	30,60
9093.21	kolor st.	prawe	25,50
9093.21	inne	prawe	30,60

MOCOWANIA SUFITOWE

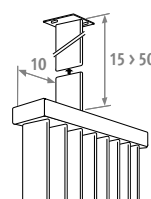

kolory standardowe: 233, 001

Kod	kolor	opis	€
9092.11	kolor st.	lewe	25,50
9092.11	inne	lewe	30,60
9092.21	kolor st.	prawe	25,50
9092.21	inne	prawe	30,60

Mocowanie ma 50 cm długości i może zostać skrócone podczas montażu.

DECO PANEL

⚠ Mocowania zostaną dostarczone w kolorze grzejnika.

MOCOWANIA BOCZNE

Poziomy

Pionowy

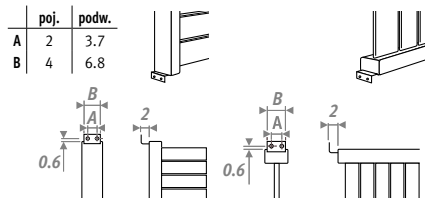

kolory standardowe: 233, 001

Kod	kolor	opis	€
9095.11	kolor st.	lewe górne	25,50
9095.11	inne	lewe górne	30,60
9095.12	kolor st.	lewe dolne	25,50
9095.12	inne	lewe dolne	30,60
9095.21	kolor st.	prawe górne	25,50
9095.21	inne	prawe górne	30,60
9095.22	kolor st.	prawe dolne	25,50
9095.22	inne	prawe dolne	30,60

Gdy zamawiane są mocowania boczne (podłączenia o kodzie 2, 3, 6, 7) są niemożliwe.

STOPKI

Poziomy

Pionowy

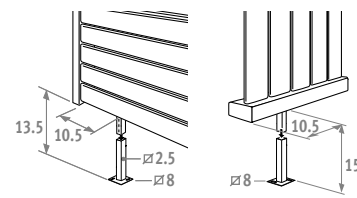

kolory standardowe: 233, 001

Kod	kolor	opis	€
9093.10	kolor st.	lewe	25,50
9093.10	inne	lewe	30,60
9093.20	kolor st.	prawe	25,50
9093.20	inne	prawe	30,60
9093.30	kolor st.	centralne*	25,50
9093.30	inne	centralne*	30,60

* Konieczne tylko w przypadku grzejnika Deco Panel poziomy podwójny od 220 do 300 cm długości.

MOCOWANIA SUFITOWE

Poziomy

Pionowy

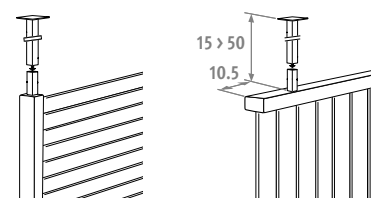

kolory standardowe: 233, 001

Kod	kolor	opis	€
9092.10	kolor st.	lewe	25,50
9092.10	inne	lewe	30,60
9092.20	kolor st.	prawe	25,50
9092.20	inne	prawe	30,60

Mocowanie ma 50 cm długości i może zostać skrócone podczas montażu.

⚠ Jeśli grzejnik montowany jest pod kątem prostym do ściany stopki i mocowania sufitowe od strony ściany nie są konieczne.

PANEL PLUS

⚠ Mocowania zostaną dostarczone w kolorze grzejnika.

MOCOWANIA BOCZNE

Typ 11

Typ 22 & 34

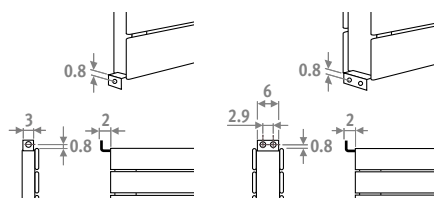

kolory standardowe: 233, 001

Kod	kolor	opis	€
9095.11	kolor st.	lewe górne	25,50
9095.11	inne	lewe górne	30,60
9095.12	kolor st.	lewe dolne	25,50
9095.12	inne	lewe dolne	30,60
9095.21	kolor st.	prawe górne	25,50
9095.21	inne	prawe górne	30,60
9095.22	kolor st.	prawe dolne	25,50
9095.22	inne	prawe dolne	30,60

⚠ W grzejniku typ 34 (grzejnik podwójny) mocowanie boczne będzie przyspawane od frontu kolektora.

STOPKI

Typ 11

Typ 22

Typ 34

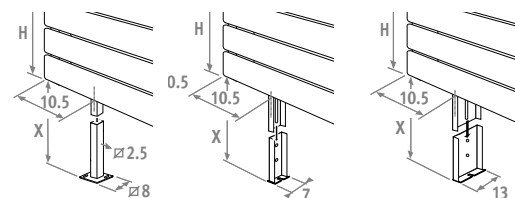

kolory standardowe: 233, 001

Kod	kolor	Typ	sugerowana H grzejnika	X (H stopki)	€
9093.01075	kolor st.	11	6-12	7.5	25,50
9093.01075	inne	11	6-12	7.5	30,60
9093.01100	kolor st.	11	18	10 > 13	25,50
9093.01100	inne	11	18	10 > 13	30,60
9093.01120	kolor st.	11	> 24	12 > 17	25,50
9093.01120	inne	11	> 24	12 > 17	30,60
9093.02075	kolor st.	22	6 - 12	7.5	25,50
9093.02075	inne	22	6 - 12	7.5	30,60
9093.02100	kolor st.	22	18	10 > 13	25,50
9093.02100	inne	22	18	10 > 13	30,60
9093.02120	kolor st.	22	> 24	12 > 17	25,50
9093.02120	inne	22	> 24	12 > 17	30,60
9093.03075	kolor st.	34	6 - 12	7.5	25,50
9093.03075	inne	34	6 - 12	7.5	30,60
9093.03100	kolor st.	34	18	10 > 13	25,50
9093.03100	inne	34	18	10 > 13	30,60
9093.03120	kolor st.	34	> 24	12 > 17	25,50
9093.03120	inne	34	> 24	12 > 17	30,60

⚠ Stopki zostaną dostarczone w kolorze grzejnika.

Ilość nóżek na grzejnik:
L 060 do 200 cm > 2 szt.
L 220 do 300 cm > 3 szt.
L 320 do 460 cm > 4 szt.

GRZAŁKI ELEKTRYCZNE DO GRZEJNIKÓW ŁAZIENKOWYCH I GEO

PODŁĄCZENIE

- Zamontuj grzałkę w grzejniku pionowo w miejscu zaworu, pozycja 1 lub 8.
- Zamontuj zawór bezpieczeństwa (3 bar).
- Nie włączaj grzałki przed wypełnieniem grzejnika wodą.
- Uzupelnij grzejnik wodą po pierwszym pełnym rozgrzaniu (nie w przypadku wersji mieszanej).

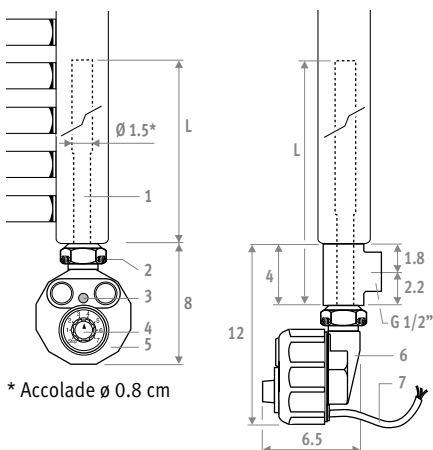

* Accolade \varnothing 0.8 cm

GRZEJNIKI 100% ELEKTRYCZNE

- Element grzewczy ze stali nierdzewnej \varnothing 1.5 cm
- Podłączenie 1/2"
- Indykator:
 - czerwony: grzałka osiągnęła maksymalny poziom grzania.
 - zielony/czerwony grzanie: kontrolowane zużycie energii.
 - zielony: zadana wartość została osiągnięta
 - nie świeci: grzejnik wyłączony
- Termostat elektroniczny
 - pozycja 0: grzejnik wyłączony
 - pozycja -: maksymalna moc
 - zabezpieczenie przed mrozem: ustaw termostat w pozycji 0. Przetaw pokrętko w prawo aż usłyszysz "klik" (indykator świeci na zielono).
- Materiał ABS white
 - Class I: IP 54
 - Class II (nie do Accolade): IP 54
- Elektroniczne sterowanie z podwójnym ogranicznikiem temperatury.
- Przewód przyłączeniowy z uziemieniem do puszkii elektrycznej:
 - długość 1.2 m
 - 230 V jedna faza - 50 Hz

APLIKACJA MIESZANA

- Zamontuj grzałkę poprzez trójnik umożliwiając podłączenie do instalacji centralnego ogrzewania.
- NIGDY nie odcinaj grzejnika od systemu zbiorczego – nie zamykaj zaworu powrotnego.

Trójnik do systemu mieszane

KOD	kolor	€
TPCE.004.009	chrom	6,90
TPCE.004.XXX	201 do 233	6,90
	301 do 333	6,90

uzupełnij kodem koloru

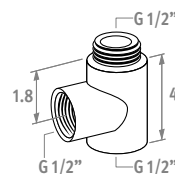

Do podłączenia z boku lub od tyłu grzejnika

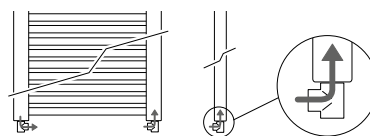

Do podłączenia mieszane

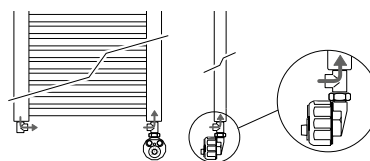

KOD	H	TYP	W	L	€
Do GEO					
Class II					
9096.21	150	100% elektryczny / mieszany - należy domówić trójnik	600	35.5	359,70
9096.23	180	100% elektryczny / mieszany - należy domówić trójnik	1200	66.0	400,60
Do SANI RONDA / SANI PANEL / SANI BOW / SANI BASIC / NAUTICA					
Class II					
9096.20	-	100% elektryczny / mieszany - należy domówić trójnik	450	31.5	350,50
9096.21	-	100% elektryczny / mieszany - należy domówić trójnik	600	35.5	359,70
9096.22	-	100% elektryczny / mieszany - należy domówić trójnik	900	51.5	380,60
9096.23	-	100% elektryczny / mieszany - należy domówić trójnik	1200	66.0	400,60
9096.24	-	100% elektryczny / mieszany - należy domówić trójnik	1500	82.0	431,20
Do ACCOLADE					
Class I					
9096.40	-	100% elektryczny / mieszany - należy domówić trójnik	450	37	298,00
9096.41	-	100% elektryczny / mieszany - należy domówić trójnik	600	47	308,30
9096.42	-	100% elektryczny / mieszany - należy domówić trójnik	900	68	324,60
9096.43	-	100% elektryczny / mieszany - należy domówić trójnik	1200	89	341,00
9096.44	-	100% elektryczny / mieszany - należy domówić trójnik	1500	110	363,70

Jaką moc grzałki wybrać?

Należy dobrać grzałkę elektryczną o mocy nie większej niż 25% powyżej nominalnej wydajności grzejnika przy parametrach 75/65/20.

GRZAŁKA ELEKTRYCZNA ECO COMFORT

Sani Ronda, Nautica, Sani Panel, Sani Louvre, Sani Basic, Sani Bow

PODŁĄCZENIE

- Zamontuj grzałkę w grzejniku pionowo w miejscu zaworu, pozycja 1 lub 8.
- Zamontuj zawór bezpieczeństwa (3 bar).
- Nie włączaj grzałki przed wypełnieniem grzejnika wodą.
- Uzpełnij grzejnik wodą po pierwszym pełnym rozgrzaniu (nie w przypadku wersji mieszanej).



100% elektryczny

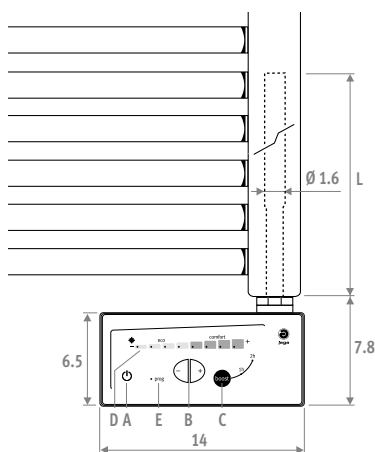

System mieszany

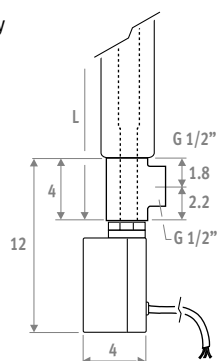

DANE TECHNICZNE

- Grzałka elektryczna class I
- w rurce ze stali nierdzewnej \varnothing 1.6 cm
- Zasilanie grzałki: 230 V jedna faza 50 Hz
- Termostat elektroniczny: 14 x 7 x 4.8 cm
- Obudowa: ABS/PC biały
- Klasa izolacji IP 54
- Nastawa temperatury otoczenia +7°C do +30°C.
- Czas trwania cyklu: 1 lub 2 godziny
- Przewód do podłączenia do gniazda z uziemieniem, długość 0.50 m

GRZAŁKA ELEKTRYCZNE Z TRYBEM "BOOST"

- Przycisk on/off.
- Nastawa temperatury (+7°C do +30°C). Pomiar temperatury otoczenia przez zewnętrzny czujnik.
- Tryb "Boost" 1 lub 2 godziny. Może być przerwany w każdej chwili.
- Indykacja temperatury poprzez niebieskie diody LED: Ochrona przed mrozem, Eco, Comfort lub Max.
- Tylko dla Francji.

APLIKACJA MIESZANA

- Zamontuj grzałkę poprzez trójnik umożliwiający podłączenie do instalacji centralnego ogrzewania.
- NIGDY nie odcinaj grzejnika od systemu wzbiórczego – nie zamykaj zaworu powrotnego.

Trójnik do systemu mieszanego

KOD	kolor	€
TPCE.004.009	chrom	6,90
TPCE.004.XXX	201 do 233	6,90
	301 do 333	6,90

uzupełnij kodem koloru

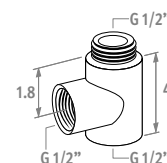

Do podłączenia z boku lub od tyłu grzejnika

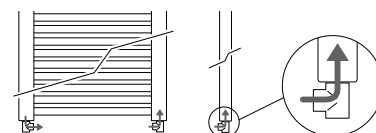

Do podłączenia mieszanego

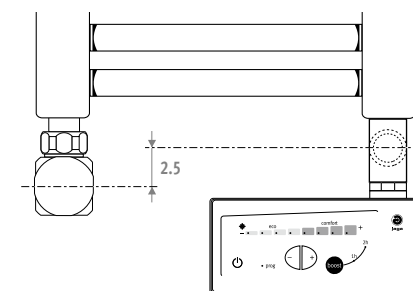
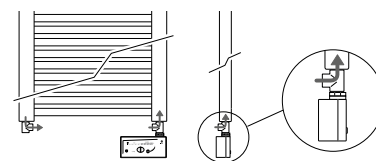

KOD	W	L	€
9096.60	600	55.0	319,60
9096.61	750	60.0	321,10
9096.62	900	69.5	329,80
9096.63	1000	72.0	338,20
9096.64	1250	85.0	338,60
9096.65	1500	96.5	343,40

⚠ Jaką moc grzałki wybrać?

Należy dobrać grzałkę elektryczną o mocy nie większej niż 25% powyżej nominalnej wydajności grzejnika przy parametrach 75/65/20.

Jaga Polska Sp. z o.o.
ul. Zwycięzców 28 lok. 26
03-938 Warszawa

Tel.: +48 22 672 88 82
Fax: +48 22 350 66 78
info@jaga.com.pl

Producent: Jaga N.V. - Belgia



Wszelkie informacje zawarte w niniejszym katalogu aktualne są w momencie jego wydruku.
W związku z polityką stałego rozwoju i innowacji, Jaga zastrzega sobie prawo do zmian specyfikacji produktów w każdym momencie.
Wszystkie ceny podane są w € i nie zawierają podatku VAT. Ceny aktualne są od 10 stycznia 2014.
Przy realizacji zamówień stosuje się ogólne warunki sprzedaży oraz warunki gwarancji dostępne na www.jaga.com.pl